



# Electronic Gaming Version

## E-max Express Operators Manual

---

© E-max Gaming Corporation.  
9900 Clinton Rd. Cleveland, Ohio 44144  
Phone 216.961.3500 • Toll Free 800.321.0757

Part number: HH1400-MNL  
Revision 2  
May, 2012

This manual should not be reproduced in any  
manner without written consent from the E-max Gaming Corporation Inc.

# INTRODUCTION

This manual will assist you in unpacking and installing the system, summarize the features of the E-max Electronics Express Bingo Console, introduce you to the E-max security system, give you a Quick Tour, and guide you through the set up of the your Console.

The Console is designed be used in conjunction with the E-max Load & Track, E-max POS, and E-max electronic gaming products to form a networked E-max integrated gaming system. All products ship from the factory pre-programmed with a DEMO program to allow you to quickly play a bingo session without spending many hours reading manuals. A set of DEMO magnetic cards for Manager, Technician, Operators, and Players are shipped with the Console. The DEMO accomplishes quick, hands-on training and understanding of system operations. Further knowledge is then derived from the manual for detailed answers to your questions such as how to setup your own organization, schedules, inventory, run reports, and tailor the system operations to your needs.

All E-max product manuals, E-max system documentation, and DEMO documentation are located on the Console's Main Menu screen under the **Help** button.

## JUMP START

The next few pages show you:

1. How the RF (radio) based system products are connected
2. How to activate the DEMO and start a bingo session in a matter of just a few minutes.

(JUMP START is shown for a Load & Track or a POS system)

**E-MAX EXPRESS  
BINGO CONSOLE**



PHONE LINE

REPORT  
PTINTER



ETHERNET



RF  
ACCESS  
POINT

**E-MAX  
LOAD & TRACK**



UPS



RECEIPT  
PRINTER



PLAYER  
CARD

**E-MAX  
GAMING UNIT**



PLAYER  
CARD

# JUMP START

## E-MAX LOAD & TRACK

1. POWER ON BINGO CONSOLE, THEN POWER ON LOAD & TRACK
2. SWIPE **SYSTEM ADMINISTRATOR** CARD ON CONSOLE
3. KEY DEFAULT PASSWORD: **13629** - THEN HIT **ENTER** BUTTON
4. HIT **PLAY BINGO** BUTTON
5. HIT **DEMO-AUTO, SCHEDULE 1** BUTTON
6. HIT **PLAY** BUTTON
7. SWIPE **SYSTEM ADMINISTRATOR** CARD ON LOAD & TRACK
8. KEY DEFAULT PASSWORD: **13629** - THEN HIT **ENTER** BUTTON
9. HIT **SALES** BUTTON
10. SWIPE **DEMO-BETTY JONES** PLAYER CARD ON LOAD & TRACK
11. HIT **E-MAX 24 FACES** BUTTON
12. HIT **END SALE** BUTTON
13. SWIPE **DEMO-BETTY JONES** PLAYER CARD ON THE E-MAX UNIT

**CALL BALLS**

# JUMP START

## E-MAX POS

1. POWER ON BINGO CONSOLE, THEN POWER ON POS
2. SWIPE **SYSTEM ADMINISTRATOR** CARD ON CONSOLE
3. KEY DEFAULT PASSWORD: **13629** - THEN HIT **ENTER** BUTTON
4. HIT **PLAY BINGO** BUTTON
5. HIT **DEMO-AUTO, SCHEDULE 1** BUTTON
6. HIT **PLAY** BUTTON
7. SWIPE **SYSTEM ADMINISTRATOR** CARD ON POS
8. KEY DEFAULT PASSWORD: **13629** - THEN HIT **ENTER** BUTTON
9. HIT **CASH DRAWER** BUTTON
10. ENTER **\$1,000** AND HIT **SAVE** BUTTON AND **NO** BUTTON
11. HIT **SALES** BUTTON
12. SWIPE **DEMO-BETTY JONES** PLAYER CARD ON POS
13. HIT **ELECTRONIC** TAB BUTTON AND **E-MAX 24 FACES** BUTTON
14. HIT **END SALE** BUTTON
15. HIT **\$50 BILL** BUTTON AND **PRINT RECEIPT** BUTTON
16. SWIPE **DEMO-BETTY JONES** PLAYER CARD ON THE E-MAX UNIT

# CALL BALLS

# SUMMARY OF NEW FEATURES

The electronics version of the E-max Express Bingo Console, produced by E-max Gaming Corporation (EGC), provides new software features to support the E-max Load & Track, E-max POS, and E-max gaming unit. All products communicate in a networked environment. All network equipment is external to the Console and described in the E-max Network Installation Manual.

## **E-max Bingo Console Compatibility:**

Training time on the new Express Console is negligible since the Express executes all same software that the existing E-max Bingo Console runs.

## **New Features from existing E-max Bingo Console:**

- All E-max products and system manuals are loaded on the Console
- Changed Deactivate button to blinking red
- Changed intermission timer to blinking red
- Added multi-level magnetic card security system
- New Setup, Utilities, and Report screens related to Load & Track, POS, and E-max units
- A new State Configuration CD to assist you in quickly setting up the E-max system to a particular State's requirement for electronic gaming
- Can be set up to play E-max units in Auto, Semi-Auto, or Manual daubing modes
- Supports Ethernet and RF (radio) network
- Supports RF or Infra-red downloading of gaming packages into the E-max unit
- Synchronizes all POS accounting to Console activation and deactivation of a Schedule
- Automatically sends Console payout information to the POS for accurate payouts
- Provides a means to help prevent low battery on the E-max unit during gaming
- Supports remote phone dial in for EGC, Regulatory, and Distributor reports
- Can print to a new networked printer

# SUMMARY OF ALERTS IN THE MANUAL

## POWER-

**Do not plug in the UPS power cord to a wall outlet until the installation of all cables is complete. Note that when trouble shooting electrical systems, be aware of the potential dangers of coming in contact with 120VAC line voltages. Use caution when handling AC power cords and devices. When feasible, during the trouble shooting procedure, turn off the AC power input when handling these devices if you are concerned with safety or call your service personnel for assistance.**

**For maximum battery backup time, allow the UPS to charge for a full eight hours prior to using the system in actual gaming.**

**CAUTION! THE CONSOLE SYSTEM MUST BE POWERED DOWN WITH THE UPS SWITCH OTHERWISE THE UPS INTERNAL BATTERY WILL DISCHARGE AND PREMATURE BATTERY FAILURE NOT COVERED UNDER WARRANTY.**

## LEGAL-

**Licensed hall owners, organizations, distributors, and game operators have prime responsibility, not EGC, to *configure* the EGC equipment and *operate* a bingo Schedule that meets Regulatory requirements in their State.**

**IF FOR ANY REASON THE EGC SYSTEM DOES NOT APPEAR TO BE IN REGULATORY COMPLIANCE, YOU MUST IMMEDIATELY CONTACT EGC LEGAL DEPARTMENT SO CORRECTIVE ACTION CAN BE TAKEN.**

## OPERATIONS-

The Console is integrated with the POS and Load & Track products and therefore, must be setup in conjunction with them. The order in which each product is setup is very important. Please review Chapters 6 and 7 before attempting to setup your particular system.

**NOTE: The E-max ball chamber uses a special antistatic mat and anti-static coated bingo balls. The anti-static properties of the Console are dependant on the use of these balls. It is recommended that only the balls that are supplied with the E-max Express Bingo Console be used.**

**General note: The very first time a function or button is used after a Console power on, will result in a longer than normal delay as the program initializes itself. Subsequent usage of the function or button will yield faster response times.**

**Since the use of E-max electronic gaming units is a revenue based function, the Console has a Renew License key utility that MUST be used periodically to allow the continued use of the gaming units. DO NOT LET YOUR KEY EXPIRE.**

**NOTE: Normally, a Schedule must be activated by a Manager or System Administrator before it can be run by a console operator. Operator+ can also activate a schedule.**

**NOTE:  
THE POS AND LOAD & TRACK PRODUCTS MUST HAVE ALL CASH DRAWERS CLOSED AND OPERATORS SHOULD BE LOGGED OFF BEFORE THE SCHEDULE CAN BE DEACTIVATED AT THE**

**CONSOLE. FAILURE TO DO SO RESULTS IN AN ERROR MESSAGE ON THE CONSOLE AND THE SCHEDULE WILL NOT BE CLOSED.**

**NOTE: THE CONSOLE AND RF ACCESS POINTS MUST BE SHUTDOWN ONCE EVERY DAY TO MAINTAIN PEAK PERFORMANCE OVER LONG PERIODS OF TIME.**

**Caution:**

**If the Console has been incorrectly set up for two ball blower cabinets, and there is only one, the image displayed for the Tear open selection can be blank or the last ball shown by the Main camera.**

**Caution: Hitting Exit during gaming and then re-entering gaming with Play on a multi-part game that had a console's auto deletion of a pattern or a caller's choice manual deletion of a pattern, will result in the original pre-programmed patterns re-appearing. The deleted pattern will be present again.**

Typically, if you are playing paper and electronics, you need to define a Paper Category and an Electronic Category that do not have the same series of faces.

TO ERASE THEMES ALREADY ON THE E-MAX UNIT, LOAD ONLY THE DEFAULT DAUBER THEME AND ALL OTHER THEMES WILL BE ERASED.

## **SOFTWARE UPGRADES & SYSTEM BACKUPS-**

**WHEN MAKING A BACKUP OF THE CONSOLE, YOU MUST ALSO IMMEDIATELY MAKE A BACKUP OF THE POS OR LOAD & TRACK BEFORE ANY OTHER ACTIONS ARE PERFORMED ON THE SYSTEM.** Note that the same physical CD cannot be used to back up the Console and POS.

**WHEN RESTORING THE CONSOLE, YOU MUST ALSO RESTORE THE POS OR LOAD & TRACK TO THE EXACT SAME POINT IN TIME.**



# Table of Contents

## INTRODUCTION

Jump Start

Summary of New Features

Summary of Alerts in Manual

## CHAPTER 1

1.0 Getting Started

1.1 Unpacking

1.2 Service Contact

1.3 Damage Action Process

## CHAPTER 2

2.0 Tools

2.1 Console Installation

2.2 Console Devices

2.3 Basic Controls

2.4 Electrical Installation

2.5 Power up the Console

2.6 Flashboard, Video, and Audio

## CHAPTER 3

3.0 Introduction

3.1 Operator Display

3.2 Ball Handling

3.3 Calling a Ball

3.4 Resetting a Ball

3.5 Ball Tray System Failure

3.6 Manual Mode

3.7 Calling a Ball in Manual Mode

3.8 Resetting a Ball in Manual Mode

3.9 Resetting the Flashboard in Manual Mode

## CHAPTER 4

- 4.0 Security / Compliance
- 4.1 Console Security
- 4.2 Initial Factory Security
- 4.3 Security Chart
- 4.4 FCC Part 15
- 4.5 Gaming Regulatory Compliance
- 4.6 Regulatory Summary
- 4.7 Renew License Key

## CHAPTER 5

- 5.0 Quick Tour
- 5.1 Log In
- 5.2 Activate Schedule – Call Balls
- 5.3 Verifying a Winner – Payout
- 5.4 Intermission
- 5.5 Deactivate Schedule
- 5.6 View and Print Reports
- 5.7 Log Off and Shutdown
- 5.8 Toolbar Functions

## CHAPTER 6

- 6.0 Setup
- 6.1 Organization
- 6.2 Category
- 6.3 Advertisements
- 6.4 Marquee
- 6.5 Pattern
- 6.6 Session
- 6.7 Schedule
- 6.8 Package

## CHAPTER 7

7.0 Utilities

7.1 Backup

7.2 Restore

7.3 Upgrade Software

7.4 Touch Screen Calibration

7.5 Setting Date and Time

7.6 Test Flashboards

7.7 E-max Gaming Unit Device Test

7.8 E-max Download

7.9 User Security

7.10 Renew License

7.11 Reports

7.12 System Logs

7.13 File Maintenance

7.14 Hardware Settings – Software Rev levels

## CHAPTER 8

8.0 Special Functions

8.1 Wild Number

## CHAPTER 9

9.0 Servicing and Cleaning

9.1 General Cleaning

9.2 Replacing the Blower Air Filter

9.3 Replacing the Armrest

9.4 Cleaning the Ball Tray Chamber

## CHAPTER 10

10.0 Troubleshooting & Diagnostics

10.1 UPS Status Indicators and Alarms

## CHAPTER 11

11.0 Warranty Information

## APPENDIX A

Console Diagrams

Computer System Connectors

AC Power Connections

Data Router Field Side Connections

## APPENDIX B

Specifications

Bingo Console Security Table

# 1.0 Getting Started

The E-max Express Bingo Console was designed to have a distinctively attractive and modern appearance. Careful manufacturing and assembly techniques are used to insure quality. Unlike the existing modular E-max Bingo Console, the Express Console is a single cabinet containing both the computer and the blower. The Console weighs approximately 240 pounds.

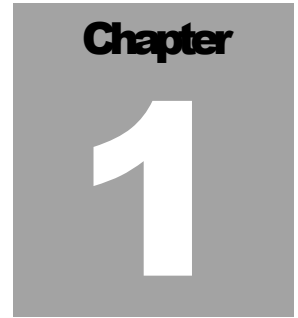

## 1.1 Unpacking Console

- ✓ Inspect the shipping containers for possible signs of damage. If damage is detected, refer to the Damage Action Process section (1.3) for procedures.
- ✓ Use scissors or box cutter to cut the straps from the skid only, taking care not to cut the straps protecting the console. With the help of at least one assistant, carefully slide the console from the skid and place it on solid flooring. Cut the remaining four straps from the console and remove the cardboard top.
- ✓ Remove the foam packing inserts from inside the top and slide the cardboard tube up and off the console. A minimum of two people are required to safely unpack the console. Never lift it by the arm rest or any part of the ball chamber or ball catcher assembly (*lift only by the console top*). With one person lifting from each end of the console, raise the console up and out from the carton and foam inserts. Check that all casters are in place. Do not destroy or discard carton or packing material until after final inspection and testing.
- ✓ At this point, you should inspect the console for any obvious shipping damage. If any problems are found, immediately contact your distributor for advice and refer to the Damage Action Process section (1.3) for procedures.

The following accessories should be found in the console:

- (1) Set of Bingo Balls
- (1) Computer mouse
- (1) Computer keyboard
- (6) Keys for cabinet doors
- (1) State configuration CD
- (1) Application CD
- (1) Recovery CD
- (1) Blank CD for Backups
- (14) Magnetic Reader Cards

## 1.2 Service Contact

For Service information or technical assistance, contact the  
**EGC Technical Assistance Center 1-800-277-6214**

## 1.3 Damage Action Process

Your Console contains delicate electronic equipment. It is imperative that you thoroughly inspect the contents of each package before accepting product delivery from the carrier.

In case of severe damage, refuse the equipment from the carrier. Contact your distributor for immediate replacement.

In case of damage, make a note on the bill of lading before accepting, take a photo of the damage, and keep the packaging to aid in recovering the amount of claim against the carrier.

If the product is damaged but acceptable, take a photo before and after unpacking as a record of the damage and contact the carrier's agent immediately for inspection. Be sure to obtain a copy of the inspection report for your records.

If these precautions are not taken, we cannot assist you in recovering the amount of the claim against the carrier.

## 2.0 Tools

### Required Tools

No tools are required for the install.

## 2.1 Console Installation

- ✓ Most likely, you would like the console to be slightly elevated and centered in the hall.
- ✓ For best anti-static operation of your console, the included bingo balls should be used. Atlas bingo balls are multi-colored and double numbered. Open the set of bingo balls. Inspect each ball for damage and insert each ball into its corresponding slot in the ball tray to ensure the set is complete. Any problems, contact your distributor for a replacement.

## 2.2 Console Devices

### Electronics Cabinet Devices

The AC junction box with GFI circuit breaker brings power into the Console and powers the UPS.

UPS (Uninterruptible Power Supply) is the main on/off switch for the Console and provides electrical power in the event of a primary AC power failure. It contains the back up power battery pack.

The Computer has an internal Data Router that drives flashboards and hall video. The Data Router is powered by the UPS and can be on even if the Computer is not on.

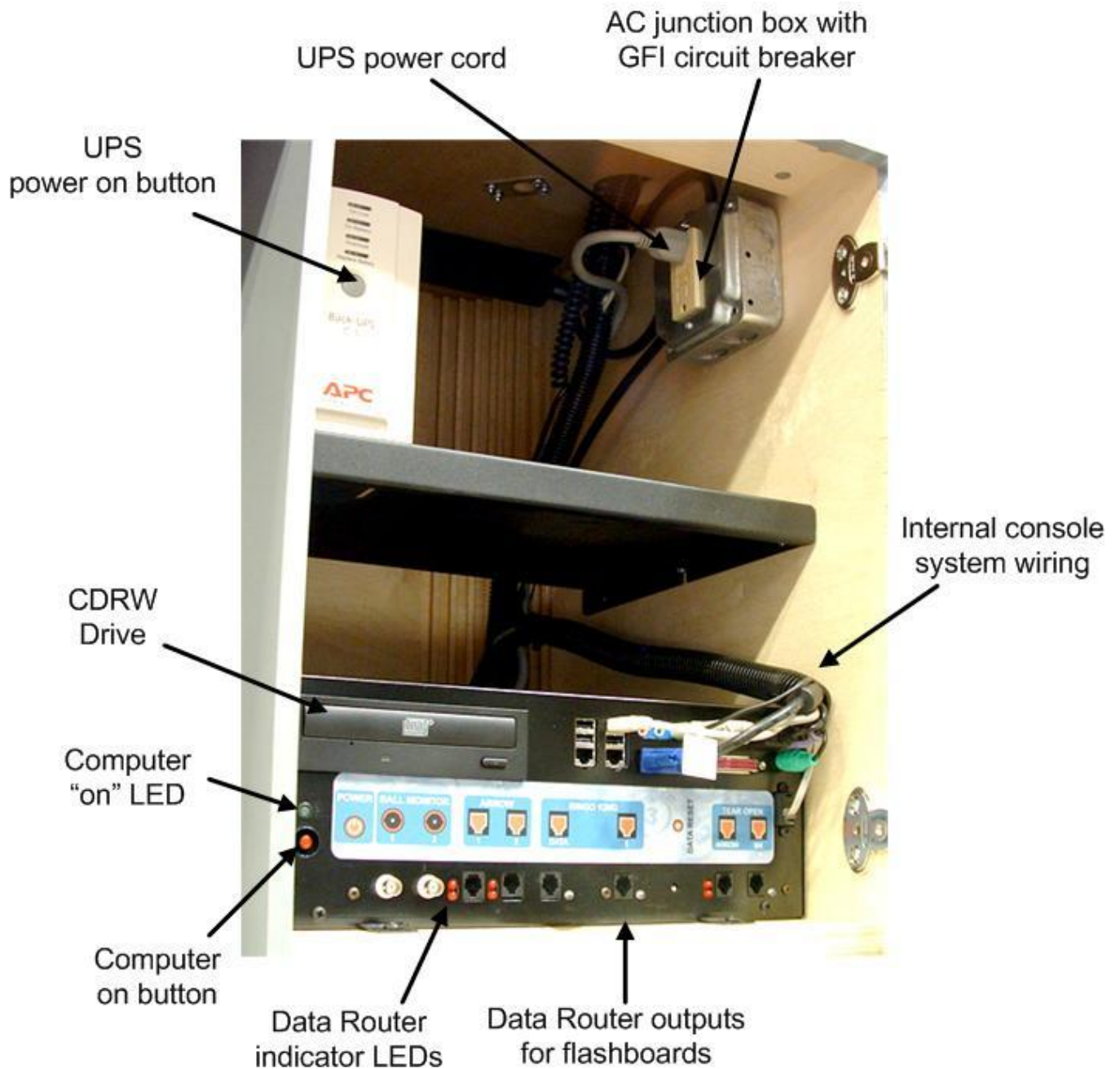



## 2.3 Basic Controls

Ball Blower Manual Controls (**Figure 2.3**) & (**Figure 2.4**)

1. Blower Switch – This is the On/Off switch for the ball blower motor
2. Ball Reset Switch and LED – This switch cancels the last ball inserted into the ball tray. (only active in Manual Mode when LED is ON)
3. Flashboard Reset Switch and LED – This switch clears all the called balls and flashboard. (only active in Manual Mode when LED is ON)
4. Ball Tray Switches – Insert ball and press down on the ball to activate the switch.
5. Two black ball release knobs – Releases balls into ball tray chamber.
6. Red Door Release knob - Releases balls into mixer chamber.
7. Ball Camera with light – Embedded digital camera and white light ball illumination.
8. Ball Tube – Centers balls extracted from mixing chamber over camera.

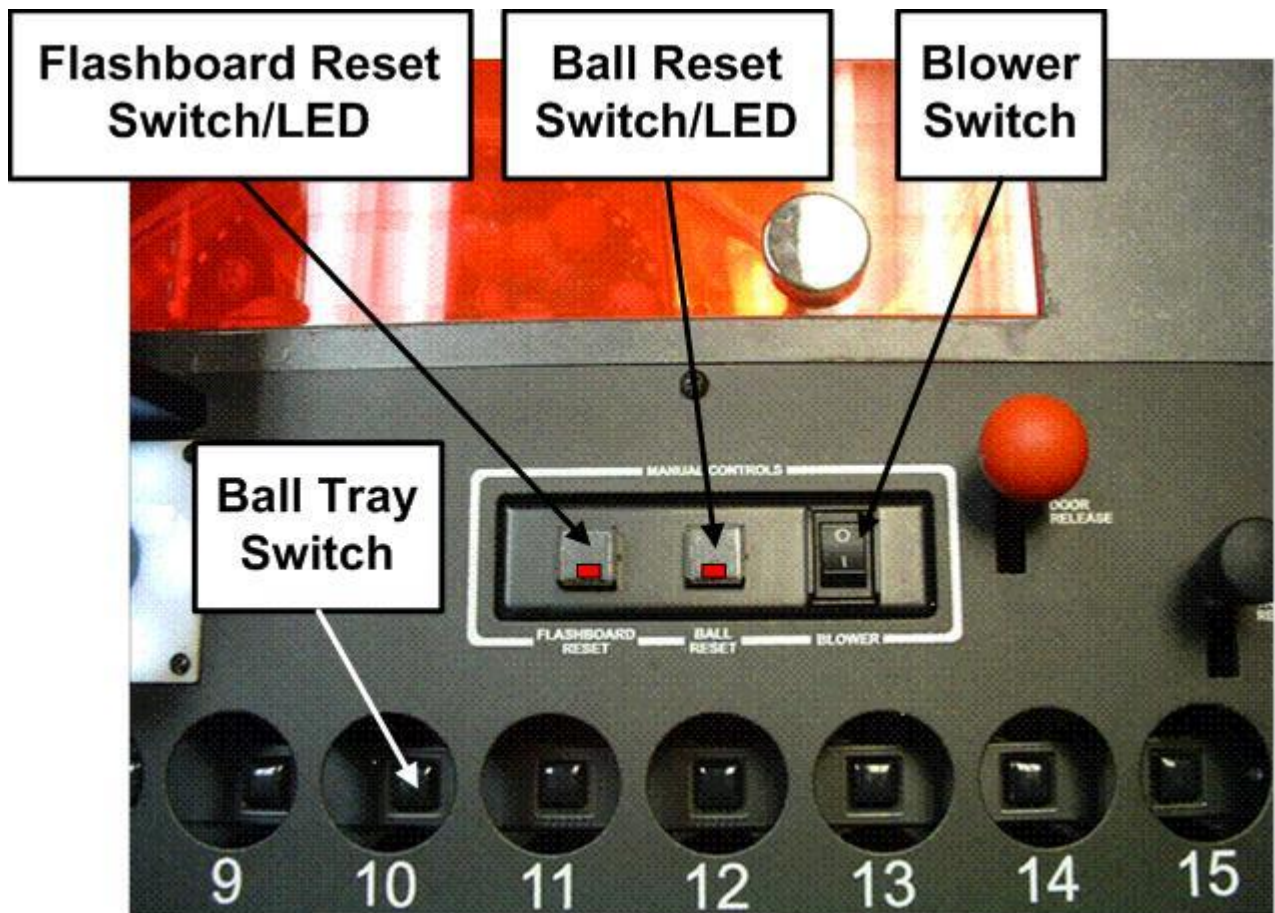

**FIGURE 2.3**

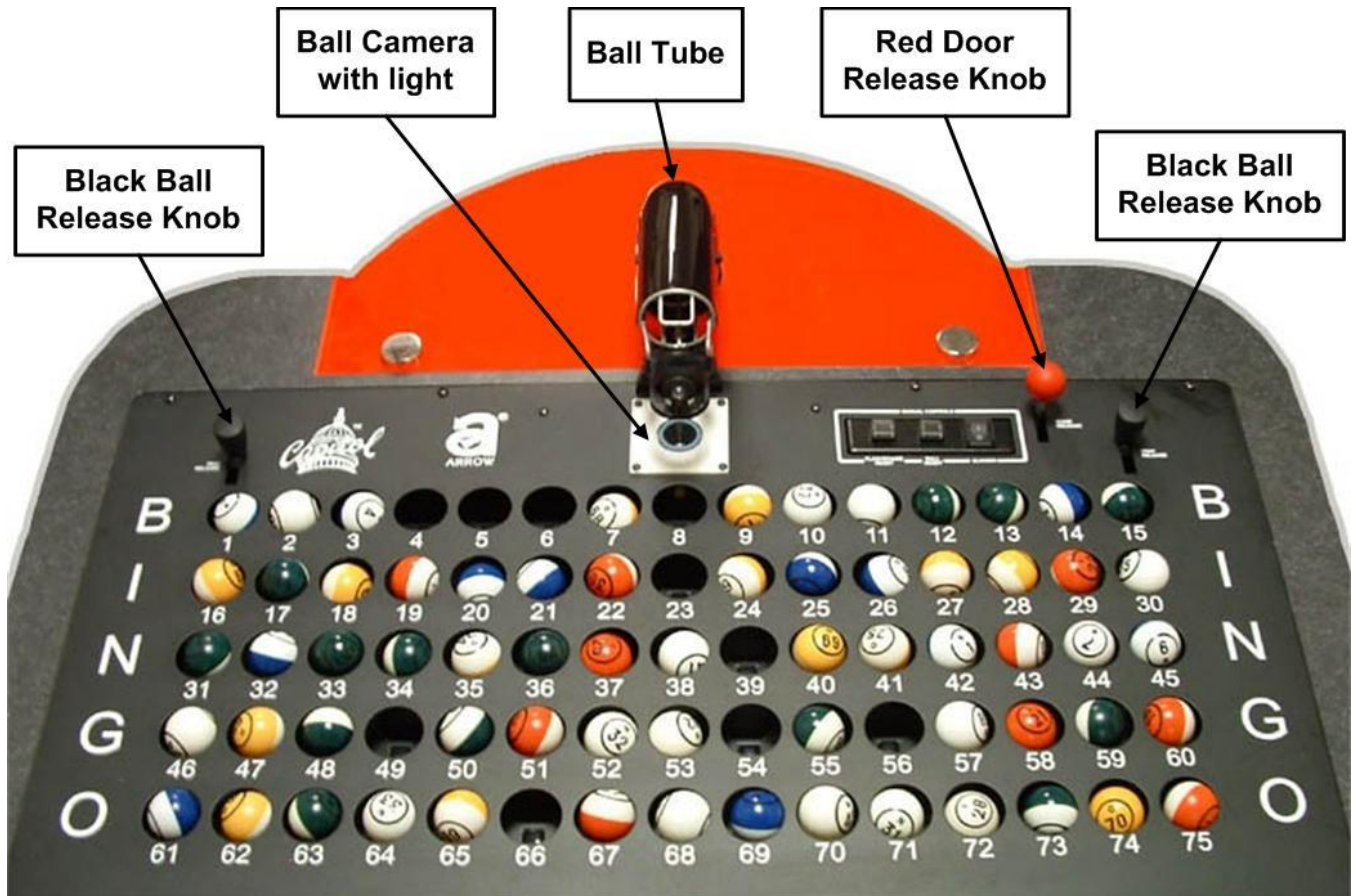

FIGURE 2.4

## 2.4 Electrical Installation

### Refer to Appendix A for Diagrams

#### CONNECT POWER SOURCE:

The main AC power input to the Console should be 115VAC, 60Hz. The power outlet or power cord to the Console should be wired with 12AWG or 14AWG with ground. The AC power input circuit must be rated for at least 15A and no other hall equipment should share this power source. Do not run long extension cords with inadequate wire gauge from the power source to the console.

**CAUTION! A POWER SOURCE WITH ABNORMAL VOLTAGE OR EXCESSIVE NOISE CAN RESULT IN IMPROPER CONSOLE OPERATION AND POSSIBLE DAMAGE NOT COVERED UNDER WARRANTY.**

The Console is provided with a 12 foot power cord with a standard three prong U.S. plug.

1. Plug the cord from Console into the main power source.

## 2.5 Powering up the Console

1. The main power “ON” switch for the electronic console is the button on the front of the UPS (Figure 2.6).

**For maximum battery backup time allow the UPS to charge for a full eight hours prior to console use.**

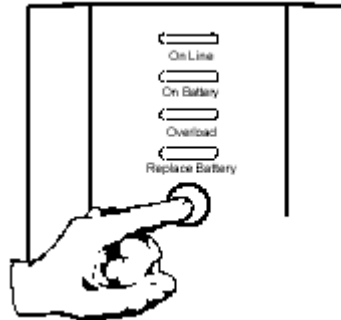

Figure 2.6

**Observe that the following events occur after pressing and releasing the push-button:**

- The green **On Line** indicator flashes.
- The yellow **On Battery** indicator lights while the Self-Test is being performed.
- When Self-Test has successfully completed, only the green **On Line** indicator will be lit and the Back-UPS is ready for use.

### **WARNING!**

If the internal battery is not connected properly, the green **On Line** indicator and red **Replace Battery** indicator will light and the UPS will also emit a chirping sound. (Call for service if this occurs).

2. Once power is applied to the UPS, the red LEDs on the Flashboard Reset switch and the Ball Reset switch should be blinking. This indicates the Data Router is operating, the computer is off, and the system is waiting for computer communications.

3. Turn on the computer by pressing the power on button on the front of the computer. The system will power up and a display will be seen on the monitor (Chapter 4). White lights on the camera ball illuminator should be on. When the computer communicates with the Data Router and the ball tray, the two red LEDs on the manual switches will turn off.

4. Turn on the blower motor switch on the console. If the blower fails to start, check the blower motor troubleshooting section (**Chapter 9**). If the motor is operational, turn it off. Release the balls into the ball tray chamber by using two hands and pulling back on both black knobs. Now release the balls into the mixing chamber by pulling back on the red door release knob and holding until all balls have entered the mixing chamber.

**CAUTION! THE CONSOLE SYSTEM MUST BE POWERED DOWN WITH THE UPS SWITCH OTHERWISE THE UPS INTERNAL BATTERY WILL DISCHARGE AND PREMATURE BATTERY FAILURE NOT COVERED UNDER WARRANTY.**

## 2.6 Flashboard, Video and Audio Installation

The Console supports a wide variety of audio, video and flashboard systems. Each installation is unique to your hall environment. Please refer to the E-max™ Bingo Console Installation Manual which describes how video, audio and flashboard systems interface to the E-max™. Your E-max™ distributor or factory representative should be consulted and assist with these installations.

## 3.0 Introduction

## Chapter

# 3

The electronic Console contains a software security key that must be activated prior to conducting bingo operations with electronic gaming units and the key must be periodically renewed to continue playing electronic gaming units. The most common way to activate and renew the key is by connecting a phone line to the Console. The Console's System Administrator can dial out of the Console to activate and renew the key. Once the key is active, the Console requires that the operator log in for security purposes, select and activate a schedule to play, and then conduct gaming functions from the Operator Display screen. After gaming is complete, the operator must deactivate the current schedule and then log off the Console. However, a Console using electronic gaming units requires the Point of Sale (POS) or Load & Track station operators to log off all of their stations before the Console schedule can be deactivated. The electronics Console can play a paper only game by not selling any gaming units, or by powering off the POS stations, or by not attaching a POS station to the Console. On the other hand, the POS stations do require the Console to be attached and powered on for the POS to be functional. The Console also takes inventory of the electronic gaming units by serial number. Financial report information of completed schedules and the gaming unit inventory information are transmitted to EGC when the software security key is renewed. Failure to renew the key disables use of electronic gaming units, but allows paper play to continue. Distributor and Regulatory agencies can use the phone line to dial in to the Console and retrieve their reports for completed schedules.

This chapter of the manual briefly describes the use of the Operator Display screen . Detailed use of the screen is provided in Chapter 5 – Quick Tour.

## 3.1 Operator Display



There are several items that make up this screen:

- Active Gaming Information (upper left corner) – This area of the screen displays the Game number, the game Part number, the Last Ball called, Total Calls , and the Dollar Value for the current game.

- Clock Display (upper right corner) – Displays the current time and date in the upper right corner.
- Organization /Schedule (upper center) – Displays the names of the organization, Schedule, Session, and current Game.
- Flashboard Screen – Displays all called balls and the last ball called (same data output as the external flashboards). Last ball called is shown in red.
- Ball Call Timer (center) – Displays a timer that counts down the number of seconds between ball calls for each game. A fast ball game will be preprogrammed to a different timer value than that of a standard, slower paced game. There are up/down arrows provided for the operator to dynamically adjust the programmed time to a different value during gaming. The timer value of zero blinks red when the time has elapsed.
- Game Pattern (center)– Displays the current game pattern being played.
- The Live Video Window (center- right side) – This window displays information for three functions:
  1. Live ad that plays at the start of the current game
  2. Live ball image from the blower camera
  3. Graphical image of the ball called when using RNG function.
- Toolbar (bottom)– The toolbar allows the operator to control and modify certain functions and change preferences during the current Schedule, advance to the next game or select a particular game to jump to, verify a winning bingo card, and exit to the Main Menu screen..
- Marquee –The current marquee will be displayed scrolling at the bottom of the screen. Marquees can be pre-programmed when a session is built, or they can be dynamically selected from the Marquee screen.

## 3.2 Ball Handling

When the blower motor is turned on, the balls momentarily mix and then 4 to 6 balls will be extracted from the mixing chamber into the ball tube. The design of the new console automatically insures that this first group of balls and all the following balls are random in nature without the need of any special pre-mixing of the balls.

The black plastic ball tube covering allows the audience to see the group of 4 to 6 balls but not pre-read the ball numbers.

The first ball extracted will come to rest at the end of the ball tube and directly over the embedded camera. The standard balls supplied with the console are double numbered. The camera views the bottom side of the ball and the operator views the top side of the ball. To adjust the ball for proper viewing on the ball monitors do the following:

1. Look at the ball, not the monitor
2. Simply rotate the ball with your fingers until the ball number is in the upright and straight position and is readable.
3. The ball will automatically appear in the correct orientation for the monitors.

\* NEW FEATURE \*

Note that the E-max Express Console requires little training for the operator compared to other bingo systems. Other systems require the operator to adjust the final position of the ball while viewing the monitor. The monitor display is a mirrored image of the ball and it takes considerable operator training to be able to adjust the ball for proper orientation. The Console allows the operator to view and adjust the ball in a natural, intuitive manner.

**NOTE: The E-max ball chamber uses a special antistatic mat and anti-static coated bingo balls. The anti-static properties of the Console are dependant on the use of these balls. It is recommended that only the balls that are supplied with the E-max Express Bingo Console be used.**

## 3.3 Calling a Ball

There are two typical methods commonly used to call balls when using electronic gaming units:

1. When the ball arrives in the tube and lands in front of the camera exposing it to players on the hall monitors, the ball number is announced to the hall and the Console operator uses his finger to momentarily depress the switch in the ball tray that matches the number on the ball. This action starts the ball timer and transmits the ball to the flashboards and to the E-max gaming units. After the ball timer has elapsed, the ball is removed from the tube and placed in the ball tray.

Therefore, the ball information is simultaneously presented to the player on the hall monitor, announced, displayed on the flashboards, and transmitted to the Auto-daub E-max gaming unit which updates its flashboard display and starts daubing.

NOTE: Depressing the ball and activating the same switch again has no effect on the system for the remainder of that game. When the system advances to the next game, the switch becomes active again.

2. When the ball arrives in the tube and lands in front of the camera exposing it to players on the hall monitors, it is not announced to the hall. After the ball timer has elapsed from the previous call, the ball is removed from the tube and placed in the ball tray and the ball is pushed down to momentarily depress the switch in the ball tray that matches the number on the ball and then the ball number is announced to the hall. This action starts the ball timer and transmits the ball to the flashboards and to the E-max gaming units.

Therefore, a paper player sees the ball in the hall monitors and can start daubing, and some time later when the ball timer has elapsed, the ball number is announced, the flashboards are updated, and the ball number is transmitted to the Auto-daub E-max gaming unit which updates its flashboard display and starts daubing.

## 3.4 Resetting the Ball

If the ball was inserted in the wrong hole then:

- Remove the ball from the hole
- On the operator monitor, touch the ball number of the wrong hole. This will reset the ball and the system will be updated.
- Insert the ball in the proper hole and depress it to activate the switch. The system is updated and correct.

## 3.5 Ball Tray System Failure

If the ball tray switches stop working, the ball should still be placed in its proper hole. The ball can be “called” by touching the ball number on the operator monitor. The system will be properly updated.

## 3.6 Manual Mode

1. In the event of the computer fails and the operator monitor is not operational, there is a system Manual Mode that allows for only fundamental bingo operations.
2. The console is designed to automatically detect a failure and switch to Manual Mode. This results in the two red LEDs on the Flashboard Reset switch and Ball Reset switch to turn on. These two switches now become active.

## 3.7 “Calling” a Ball in Manual Mode

1. To “call” the ball, remove the ball from the ball tube and insert the ball into its corresponding numbered hole in the ball tray.
2. Momentarily depress the ball to activate the switch associated with that ball.
3. The Flashboard will be updated.

## 3.8 Resetting a Ball in Manual Mode

If the ball was inserted in the wrong hole then:

- Remove the ball from the hole
- Hold down the switch in the wrong hole and then momentarily depress the Ball Reset switch.
- Release the switch in the wrong hole.

## 3.9 Resetting the Flashboard in Manual Mode

To advance to the next game:

- Hold the Flashboard Reset switch down for at least 2 seconds until the flashboards clear.
- All of the individual ball switches are now active again for calling new balls. All previous ball information is lost.



## 4.0 Security / Compliance

### Chapter

# 4

### 4.1 Console Security

Regulatory agencies, hall owners, and casino management are requiring more security and tracing of system operations. The Console uses standard EGC security methods common to most all of our electronic gaming equipment. A system user is required to do a secure log in to the system before accessing features and functions.

There are many levels of security on the system:

1. Operator
2. Operator+
3. Manager
4. Technician
5. System Administrator
6. Regulatory
7. E-max Support

Each operational feature available on the Console is assigned to one or more of these levels. The System Administrator, with the highest security clearance, has access to all features, while the Game Operator has access to a more limited set of features.

#### **Sophistication or Simplicity:**

**The Console can accommodate both.**

Our multi-level security system meets the tough demands of sophisticated halls with multiple organizations. For small charitable operations, only the System Administrator card is needed, thereby eliminating all security logic and associated complexity. **However, it is recommend that a System Administrator card and a Manager card be used for even the smallest of organizations to protect sensitive system settings that only the System Administrator should have access to.**

**The following discussion describes more details of the nature of sophisticated security.**

For some security levels, entire features or screens are disabled and not even shown to the user. In other cases, certain buttons and selections on the screen are grayed out or disabled. Some transactions performed by some operators may require a manager's approval. The manager can enter his security information to allow the transaction to be completed by the operator.

The System Administrator is the key individual that sets up system security and operations.

Every person that gains access to the system must have two items:

1. A magnetic card (or know your assigned card number)
  - a. Card can be swiped or card number manually keyed
2. Know your password that was entered into the system with the System Administrator
  - a. Password must be manually keyed

For each system user, the system stores:

1. User Name
2. Password
3. Security level
4. Magnetic Card Number
5. An association of the user to one or more organizations

The last item (5) is required since a single Console in a hall may be used by several organizations. When a user logs in to the system, a list of organizations is shown that can be accessed by that user. So, if a manager logs in and manages three different organizations of the five organizations using the hall, only those three organizations will appear in the list. The system security can also be set up such that a user is only allowed access to a single organization. The screen below illustrates that Operator 2 has access to only two organizations, Auto & Semi-auto shown on the right. He does not have access to the other organizations on the left side.

The screenshot displays a user management interface with the following components:

- User List:** A list of users including Demo-Manager, Demo-Operator+, Demo-Operator1, Demo-Operator2 (highlighted), Demo-Technician, and System.
- User Details:** Fields for User Name (Demo-Operator2), Card # (0000000315), and Password (masked with asterisks).
- Security:** Radio button options for Console Operator, Console Operator Plus, Console Manager, Technician, and System Administrator.
- Organizations:** Two columns: Available (Demo - Autotrst, Demo - Manual, Demo - Paper) and Selected (Demo - Auto, Demo - Semi-Auto), with left and right arrow buttons between them.
- Navigation:** A vertical sidebar on the left with buttons for User/Group Security, E-max Download, Utilization Report, Revenue Share Report, Device Load Report, Gaming Report, Payout Report, Frequency Report, Device Report, Downloader Log, Package Builder Log, and Error Log.
- Actions:** Buttons for Add New User, Edit User, Delete User, Save, Cancel, and Exit.

There is also a security level associated with the entry of user security data into the system:

1. There is only one System Administrator assigned to the Console.
  - He can enter and edit user data for all levels of security
  - He is automatically associated with all organizations in the database.
  - He can Activate and Deactivate Schedules
2. Managers can enter and edit user data for Operators and also change their own data
  - Managers can be assigned to a single or multiple organizations
  - Managers can Activate and Deactivate Schedules
3. Operators cannot enter or edit user data.
  - Operators can change their password with the assistance of a Manager.
  - Operators can be assigned to a single or multiple organizations
  - Operators can not Activate and Deactivate Schedules
4. Operator + does not need a password and can Activate and Deactivate Schedules

When assigning passwords for an Operator, one should use an easy number to remember since many volunteer operators may use their password infrequently.

**Passwords are a minimum of 4 and a maximum of 10 numeric digits.**

The system requires a user to “Log On” to the system before access is granted. Only one user can be logged on the system at a time. Therefore, a current user must “Log Off” the system for a new user to take control of the system.

To log on to the E-max Bingo Console:

1. Slide your user Magnetic card through the reader
2. Enter your user password
  - a. With finger touch
  - b. With mouse cursor and clicks on the video keypad
  - c. With the keypad
3. Touch the **ENTER** button.

Manager, operator, technician, and player cards are standard EGC E-max out-of-box cards that can be assigned and replaced in the hall.

**Note: The System Administrator and E-max Support Manager magnetic cards are included with the Console. They are not standard cards and must be ordered from EGC. Keep the cards in a safe place and protect them from damage.**

## 4.2 Initial Factory Security

On a factory new Console, EGC loads a Name and Password into the database for a System Administrator. This loaded information will be given to the proper personnel when installing the new system. The System Administrator must log in to the system and set up other users before others can use the system. An EGC service representative or an authorized EGC distributor can provide assistance in the set up.

## 4.3 Security Chart

Refer to the Appendix Security Charts for a complete list of system access for each level of security.

The first level of access for the Main Menu is as follows:

<b>Main Menu Function</b>	<b>Operator (Operator +)</b>	<b>Manager</b>	<b>Technician (4)</b>	<b>Sys Admin</b>	<b>Regulatory (4)</b>	<b>E-max Support</b>
Multiple Organizations	NO	YES (1)	YES	YES	NO	NO
Activate	NO OP+, YES	YES	YES	YES	NO	NO
Play Bingo	YES	YES	YES	YES	NO	NO
Setup	NO	YES	YES	YES	NO	NO
Utilities	YES (5)	YES (5)	YES (3)(5)	YES	YES (5)	NO
Deactivate	NO OP+, YES	YES	YES	YES	NO	NO
Log out	NO	YES	YES	YES	YES	NO
Restart	YES	YES	YES	YES	YES	NO
Shutdown	YES	YES	YES	YES	YES	NO

## 4.4 FCC Part 15

The Console computer, the system printers, and the UPS devices are all pre-tested by their corresponding manufacturers and certified to meet FCC part 15 requirements.

## 4.5 Gaming Regulatory Compliance

If properly configured and **operated**, the EGC E-max Express Bingo Console, E-max Load & Track, and E-max gaming unit system can comply with many different Regulatory requirements for the function that the system performs.

The E-max system employs a State Configuration CD to reasonably configure the Console, Load & Track, and POS system to be reasonably compliant to the state in which they are installed. During installation of the E-max system, the state licensed and EGC authorized distributor is required to load the State Configuration CD onto the E-max product(s) and select the State that it is being installed in. The system then places reasonable restrictions on the operation, sales, and loading of EGC E-max gaming units. The State Configuration CD is a **tool** that reduces human error and makes it easier and faster for distributors and organizations to set up the equipment to state requirements. **The CD does not make the system compliant to every rule imposed on Bingo by the given State.**

Since Regulatory requirements from all states are continuously changing, this CD is updated periodically to stay in reasonable compliance to the best of EGC knowledge. **EGC assumes no liability for the absolute accuracy of the CD content at any point in time. To determine what current restrictions are placed on the system by this CD, and the States that the E-max system has been approved by, please contact EGC legal department for the latest information.**

**Licensed hall owners, organizations, distributors, and game operators have prime responsibility, not EGC, to *configure* the EGC equipment and *operate* a bingo Schedule that meets Regulatory requirements in their State.**

**IF FOR ANY REASON THE EGC SYSTEM DOES NOT APPEAR TO BE IN REGULATORY COMPLIANCE, YOU MUST IMMEDIATELY CONTACT EGC LEGAL DEPARTMENT SO CORRECTIVE ACTION CAN BE TAKEN.**

The E-max system supports Regulatory card swipes on the equipment and execution of regulatory verification programs. The E-max system also supports Regulatory phone dial in to the E-max Express Bingo Console to retrieve gaming data. Refer to the Appendix for content of a typical Regulatory dial in report.

The State Configuration CD can be loaded onto the Console using the **Utilities** button on the Main Menu screen and then the **Upgrade Software** button as described in Chapter 7 of this manual.

## 4.6 Regulatory Summary

### In general, the E-max system tracks, reports, and logs:

- E-max unique device ID
- Unique E-Face ID of a package loaded into a specific E-max unit
  - Restricts total number of faces that can be sold and loaded into an E-max gaming unit
- Can print actual faces contained in the E-Face ID package
- Voids and reloads of those faces and device IDs
- Net total number of gaming units and total face count that can be billed for revenue purposes
- Name, quantity, and dollar amount of total sale of the packages
- Date/time stamps of when those packages and devices were loaded, voided, and reloaded.
- Linking of individual players to those devices and packages
- Phone dial-in to the E-max console can retrieve a E-max Regulatory report
- Prints sales, voids, and reload receipts with a unique, sequential receipt number
  - Number can be reset only by management and is bar-coded on the receipt
  - All pertinent sales, item, quantity, and tax information
  - E-face and gaming Device IDs
  - Player and operator names and operator station ID
  - Schedule and organization name, address, phone number, and license number
  - Free form text footer for various messages to meet hall or regulatory requirements
- Gaming data logging and statistics
- Error logging
- Software revision levels in clear view on the log in screens of all equipment
- A Management screen on the E-max gaming unit shows during gaming:
  - Details of the package that got loaded
  - Logging of events and balls called on the E-max
  - Unit configuration
  - Power status
  - Error log
  - RF network information
  - Resident software revision levels
  - Resident hardware diagnostics to verify unit performance can be run pre or post gaming
- Stores 13 or more months of historical data
- System requires a periodic renewal key to continue to load E-max electronic gaming units
  - Electronic sales halted for failure to report gaming data or pay for units played

## 4.7 Renew License Key

**Since the use of E-max electronic gaming units is a revenue based function, the Console has a Renew License key utility that MUST be used periodically to allow the continued use of the gaming units. DO NOT LET YOUR KEY EXPIRE.**

An expired license key will disable the use of gaming units, but allow a paper base game to play. Since key renewal is accomplished from corporate EGC, the Console should be connected to a dedicated, standard dial up phone line to allow the real time generation of a new key. If a phone line is not available, contact your Distributor to decide on the best way to manually renew your key.

Each specific Console must have an existing contract with EGC for the gaming units to receive a key. Play of gaming units is disabled as shipped from the factory and an initial key must be obtained from EGC.

You must be a System Administrator to renew the key. Use the **Renew License** program found under **Utilities** on the **Main Menu** screen as described in **Chapter 7**. Use of this utility forces the Console to dial out to EGC to retrieve the key. The number of days the new key allows you to play gaming units is a function of your arrangement with your Distributor and EGC.



## 5.0 Quick Tour

Chapter

5

Quick Tour takes you through the basic steps required to play a bingo Schedule. Quick Tour will discuss:

- ❖ Log in to the Console
- ❖ Activate a Schedule and Call Balls
- ❖ Verify a winner and make a payout
- ❖ Intermission
- ❖ Deactivate a Schedule
- ❖ View and print reports
- ❖ Shutdown

NOTE:  
AFTER completing the Quick Tour, to create your own Schedules, see Chapter 6

Quick Tour uses the pre-loaded E-max **DEMO** program to conduct a bingo Schedule. The internal security system was setup such that only the System Administrator has access to the **DEMO** organizations. This was done so that console Operators will see just their real organization Schedules on a daily basis and not the DEMO list.

**Quick Tour describes only basic functions to run the Schedule. At the end of Quick Tour, other special and more detailed features available on the Console are discussed.**

**General note: The very first time a function or button is used after a Console power on, will result in a longer than normal delay as the program initializes itself. Subsequent usage of the function or button will yield faster response times.**

*Let's begin...*

## 5.1 Log In

To start the Quick Tour you must first apply power to the Console. The system will take a few moments to boot up which will bring you to the **Login** screen.



Note that the State which the system is configured for is depicted by the regulatory “seal”.

Swipe the System Administrator magnetic card through the card reader and enter the factory default password of **13629**, then hit the **ENTER** button.

The **ENTER** button causes the **Main Menu** Screen to appear.



## **PLAY BINGO**

- Get to the Organization / Schedule screen and activate a Schedule

## **SETUP**

- Edit or make new Organizations, Schedules, and associated activities and patterns

## **UTILITIES**

- Edit security users
- Retrieve and print Schedule reports
- Load E-max units with new application software and themes
- View hardware setup and software revision levels
- Perform backup, restore, upgrade software, and log maintenance functions
- Set date and time
- Calibrate the touch screen
- Perform flashboard lamp test
- Perform quick test of RF link and find the E-max head count
- Renew the EGC license key via dial in
- View error logs

## **HELP**

- Allows you to select an E-max product or system manual from a list of many manuals

## **LOGOUT**

- Logs the current operator off the Console

## **RESTART**

- Will reset the Console computer and bring you back to the **Log In** screen

## **SHUTDOWN**

Will totally shutdown the computer

## 5.2 Activate Schedule - Call Balls

Touch the **PLAY BINGO** button and the **Schedule** screen will appear. This screen displays a list of preprogrammed Schedules on the left side of the screen, details about those Schedules on the right side of the screen.

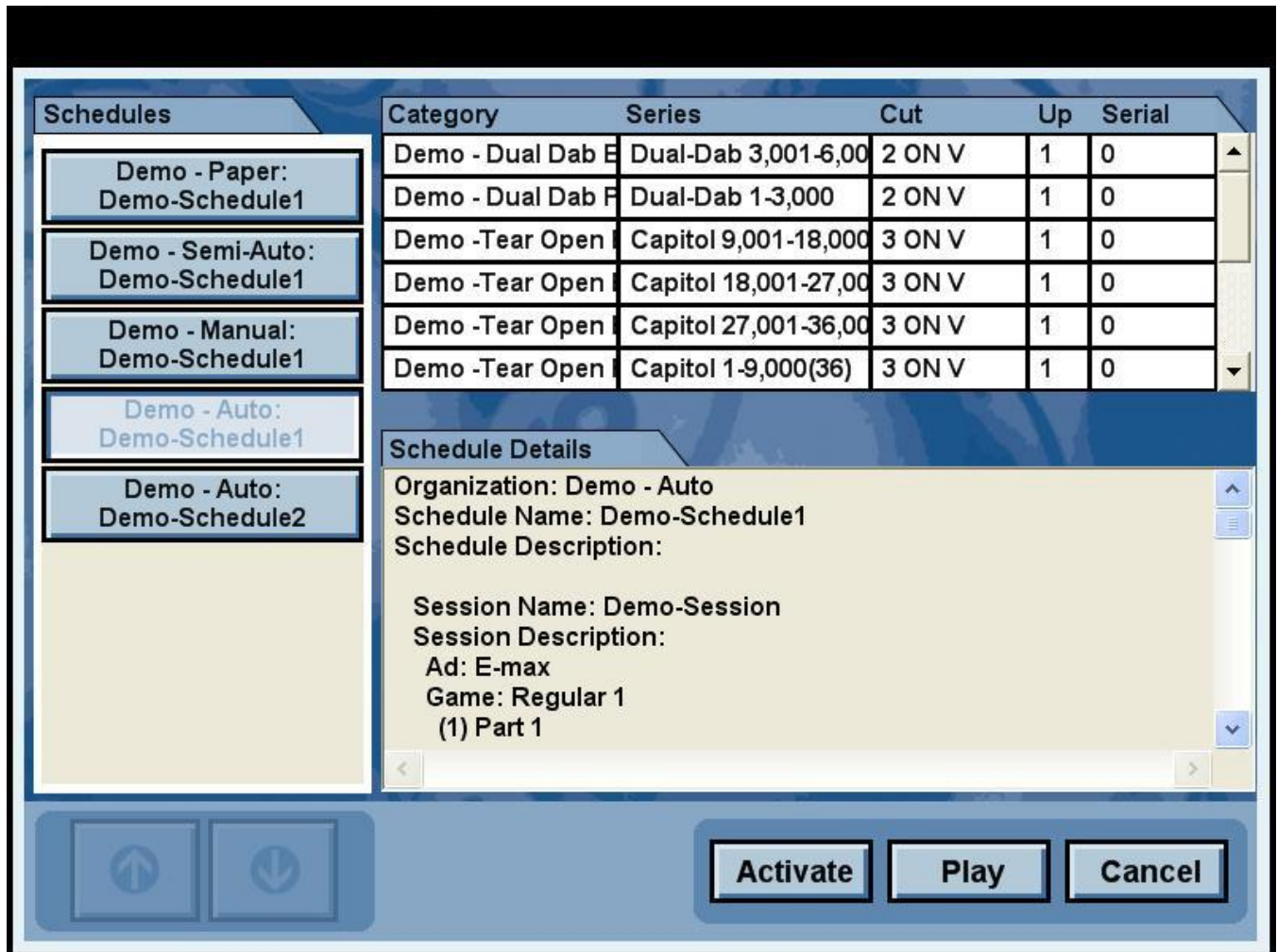

Select the **Demo-Auto: Demo-Schedule 1** button on the left side of the screen and then touch the **PLAY** button which activates the Demo-Schedule 1.

**NOTE: Normally, a Schedule must be activated by a Manager or System Administrator before it can be run by a console operator. Operator+ can also activate a schedule.**

The POS or Load & Track operator(s) can now log onto those products and start sales activities. Refer to the **JUMP START** procedure shown in the Introduction.

The **Live Game** screen is now displayed.



Call balls as previously discussed in Chapter 3.

As balls are called and placed in the ball tray, the called ball will be shown on the flashboard area of the screen. Continue calling balls until a winner has been declared from the floor.

If the game is preprogrammed to include a wild ball(s), the **BINGO** text on the left side of the flashboard area will turn into a **WILD** button. Touching the button will active whatever type of wild ball has been preprogrammed.

The Console will then automatically call/daub the correct wild balls.



## 5.3 Verify a Winner - Make a Payout

Touch the **VERIFY** button located on the toolbar. This will bring up the **Enter New Card** screen.



The paper and electronic categories for the session being played will appear on the top of the Category list and will not have parenthesis around them. If more than one Category is programmed for a bingo session the Console will perform an **Auto Search** of all the programmed Categories in order to determine a valid winner.

If you are playing a different Category from the one that is programmed, you can choose a Category on the left side of the screen to specify the perm you wish to verify.

Enter the free space number of the winning card, then hit **ENTER**.



The **Verify / Payout** screen is now displayed.

**Verify / Payout**

Game # 1  
Part # 1/1  
Last Ball 35  
Total Calls 5  
Dollar Value \$75

Serial # 0

(Standard)				
B	I	N	G	O
1	16	31	46	65
5	17	33	47	64
3	18	Free 34	49	63
4	19	34	48	62
2	20	35	50	61

Winner 34

#	Category	Card#	Payout
1	(Standard)	34	\$50.00

Buttons: Next, Add, Remove, Change, Done, Save, Cancel, EXIT

Good Luck Welcome to Our Bingo Hall - Good Luck Welcome to Our Bingo Hall - Good Luck

**Winner** or **Not a Winner** will be displayed on the lower left portion of the card with the last ball number flashing.

If not a winner, the payout screen will display the first card type with the entered free space number. Hit the **CANCEL** button to return to the **Live Game** screen.

If a winner, and there are no other cards are on the floor being declared as winners, hit the **DONE** button. This will take you back to the **Live Game** screen and automatically advance the session to the next game or next part number of the current game.

If more than one winner exists, hit the **NEXT** button to enter in another card number to verify multiple winners, then hit **DONE** to take you back to the **Live Game** screen and automatically advance the session to the next game or next part number of the current game.

## 5.4 Intermission

Continue calling and verifying each game until the **Intermission** screen appears.

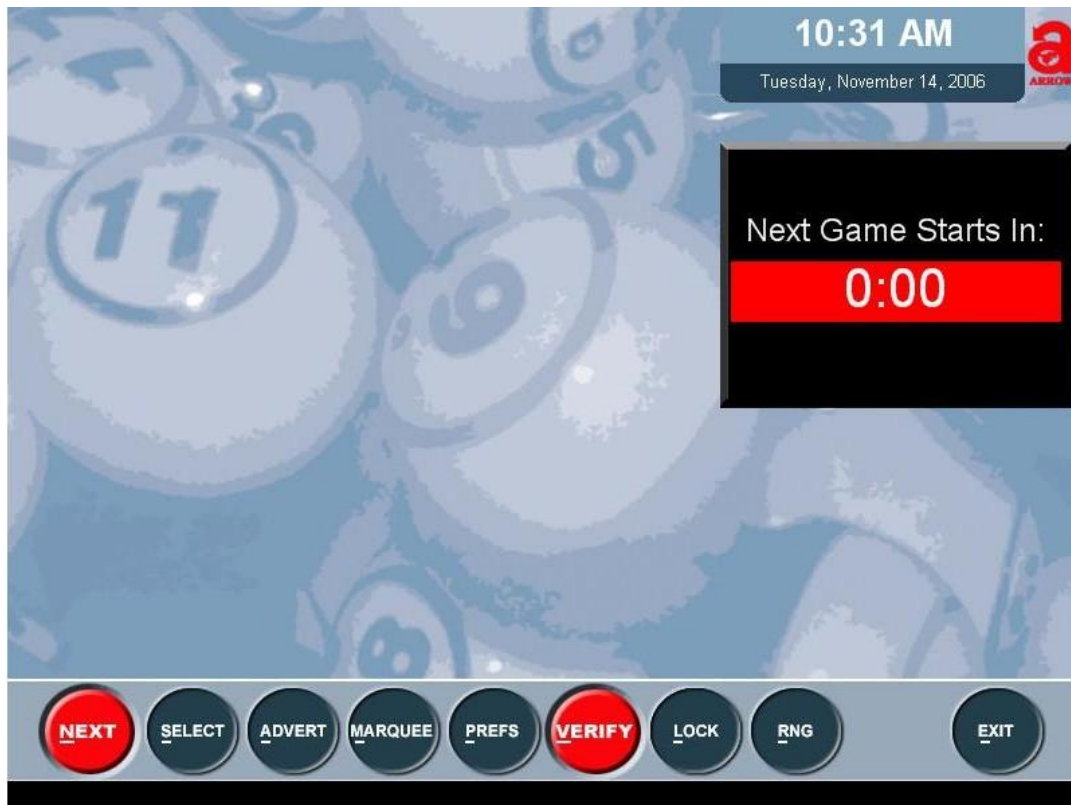

The screen displays a count down timer. When the time has elapsed, the zero value will flash red. To terminate the intermission and return to bingo play, hit the **NEXT** game button on the toolbar.

## 5.5 Deactivate Schedule

Continue calling and verifying each game until the end of the Schedule is reached.

Hit the **EXIT** button on the toolbar to take you back to the **Main Menu** screen. The **DEACTIVATE** button will be red to remind you to deactivate the Schedule before shutting down the Console.

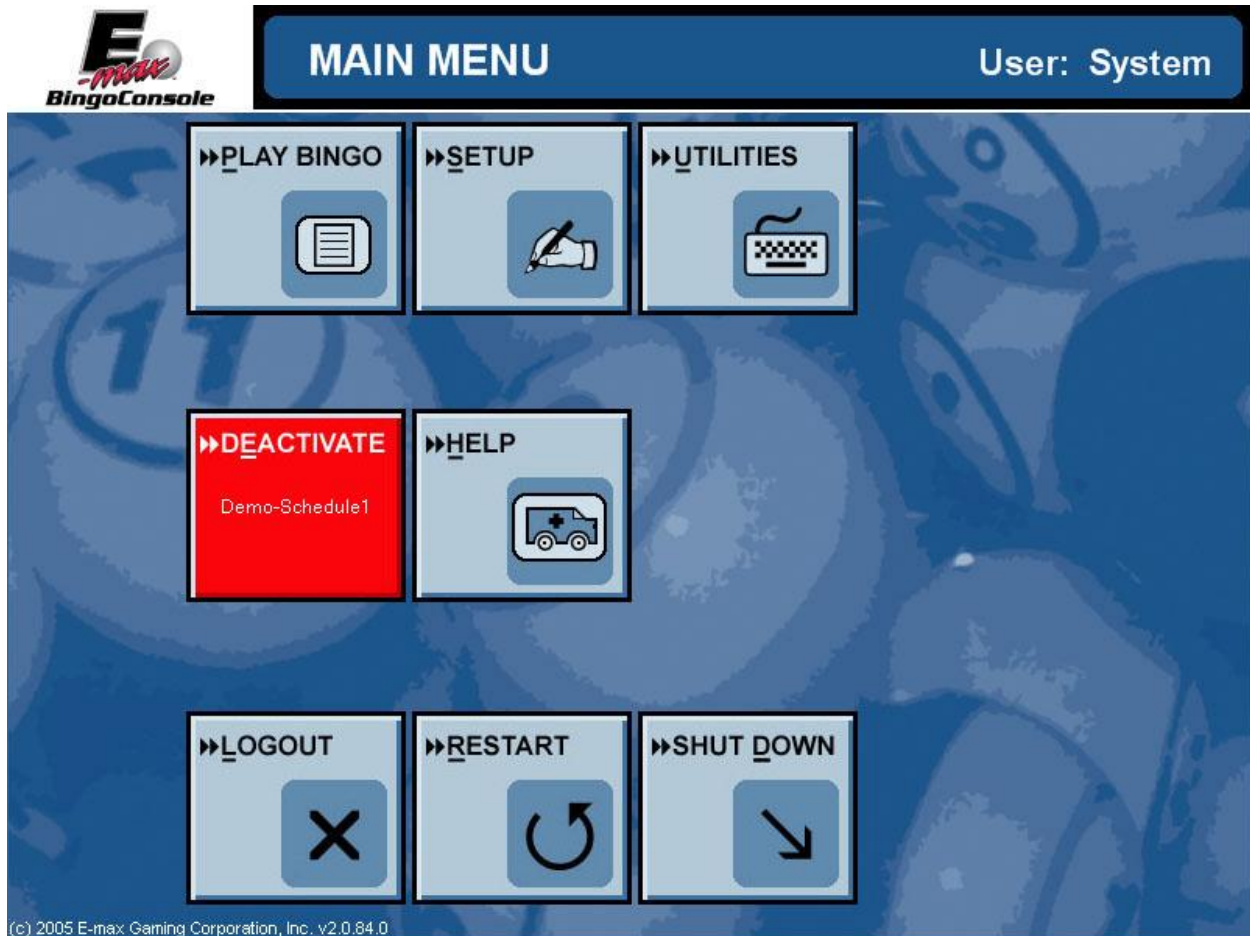

**NOTE: THE POS AND LOAD & TRACK PRODUCTS MUST HAVE ALL CASH DRAWERS CLOSED AND OPERATORS SHOULD BE LOGGED OFF BEFORE THE SCHEDULE CAN BE DEACTIVATED AT THE CONSOLE. FAILURE TO DO SO RESULTS IN AN ERROR MESSAGE ON THE CONSOLE AND THE SCHEDULE WILL NOT BE CLOSED.**

Pressing the **DEACTIVATE** button will result in a prompt message to confirm this action.

Depending on the setup of the Console, a second prompt message may appear asking if you want to save the gaming data for the Schedule just played.

Note: If the POS or Load & Track are powered off prior to deactivate, then the Console will take longer than normal to deactivate the Schedule.

At this point, you are on the **Main Menu** screen and the Schedule is officially closed.

## 5.6 View and Print Reports

Hit the **UTILITIES** button on the Main Menu screen to view gaming reports for the Schedule.

To view one of the reports, select the desired report button and the Schedule selection screen will appear. The last completed Schedule will appear in the list at the top of the screen and the report for that Schedule will automatically be displayed. Use the **NEXT PAGE** and **PREVIOUS PAGE** buttons to scroll through a multi-page report. Hit the **PRINT** button to print the report. Repeat for each report that needs to be printed.

**Schedule:** Demo - Auto:Demo-Schedule1  
**Date:** 11/13/2006 11:27:19 AM

**Payout Report** Print Date: 11/14/2006

**Demo - Auto**

**Schedule: Demo-Schedule1** 11/13/06 11:27 am

**Session:** Demo-Session  
**Game:** Regular 1  
 ( 1 ) Part: 1 / 1

Category	Series	Card#	Payout Date	Face
Demo-Electronic	E-max 1-100,000	74	\$75.00 11/13/06 11:59 am	12 32 32 21 06 8 18 45 55 75 3 17 10 49 52 10 21 41 47 70 4 28 37 40 64
<b>Part Total:</b>			<b>\$75.00</b>	
<b>Game Total:</b>			<b>\$75.00</b>	

**Game: Regular 2**  
 ( 2 ) Part: 1 / 1

Category	Series	Card#	Payout Date	Face
Demo-Electronic	E-max 1-100,000	39	\$50.00 11/13/06 12:01 pm	5 18 30 53 72 3 28 44 58 73 12 27 0 40 62 13 23 37 57 65 9 20 21 50 88
Demo-Electronic	E-max 1-100,000	75	\$50.00 11/13/06 12:01 pm	7 22 34 57 67 12 22 44 50 68 3 28 11 43 73 5 22 42 59 72 13 20 33 52 65

Current Page No: 1 Total Page No: 4 Zoom Factor: Page Width

Previous Page Next Page Transfer  
 Print Write To Disk Exit

The following closed Schedule reports are available:

### Standard Gaming Reports:

**Payout** - Shows for each game in the Schedule: the game name, Category, Series, free space number(s), payout amount(s), Date and Time of each payout, actual card face(s) with the winning pattern, and a total payout amount for the sessions and the completed Schedule.

**Gaming** - Displays the Operator name, all of the above payout information, and in addition for each game in the Schedule and each ball called: how many balls were called, the number of each ball called, the type of call (regular or Wild), and the time each ball was called. At the bottom of the report is a summary list of the Schedule showing all the game names, payout amounts and whether paper and/or electronics was played.

**Frequency** - Graphically and numerically shows how many times each ball was called for all the games in the Schedule.

**Electronics Reports:**

Utilization – Displays the total number of E-max units Voided and Played for the Schedule. Also, for each individual E-max unit: E-max unit ID number, E-Face ID of the package loaded, the player tracking card number, the number of total faces loaded, date/time stamp of the load, and if the unit was voided.

Revenue Share – Shows how many E-max units the Schedule will be billed for and the total faces loaded for the Schedule. This report is sent directly to EGC.

Device Load- Displays the total number of E-max units Voided, Reloaded, and Played for the Schedule. Also, for each individual E-max unit: the sales receipt number, E-max unit ID number, E-Face ID of the package loaded, the player tracking card number, sold time, load time, an external system reference number, and if the unit was voided or reloaded.

Device- Shows for each E-max unit that was powered on and ready for gaming in the hall, rather loaded or not: the E-max unit ID number, the IP address, the network MAC address, and the battery pack information (or an indication that the E-max unit was line powered).

## 5.7 Log off and Shutdown

With the Schedule closed and all reports printed, the operator can log off the Console by hitting the **LOGOUT** button on the **Main Menu** screen.

If the Console is to be shutdown, then hit the **SHUTDOWN** button on the **Log In** screen. Prompt messages will appear reminding you to back up your system and confirm the shutdown.

**NOTE: THE CONSOLE AND RF ACCESS POINTS MUST BE SHUTDOWN ONCE EVERY DAY TO MAINTAIN PEAK PERFORMANCE OVER LONG PERIODS OF TIME.**

## Quick Tour is now complete.

To learn about additional features that the Console has to offer, please continue reading the following sections that describe Console features in more detail.

## 5.8 Toolbar Functions

The system **Toolbar** located at the bottom of the **Live Game** screen allows you to control all live gaming operations.

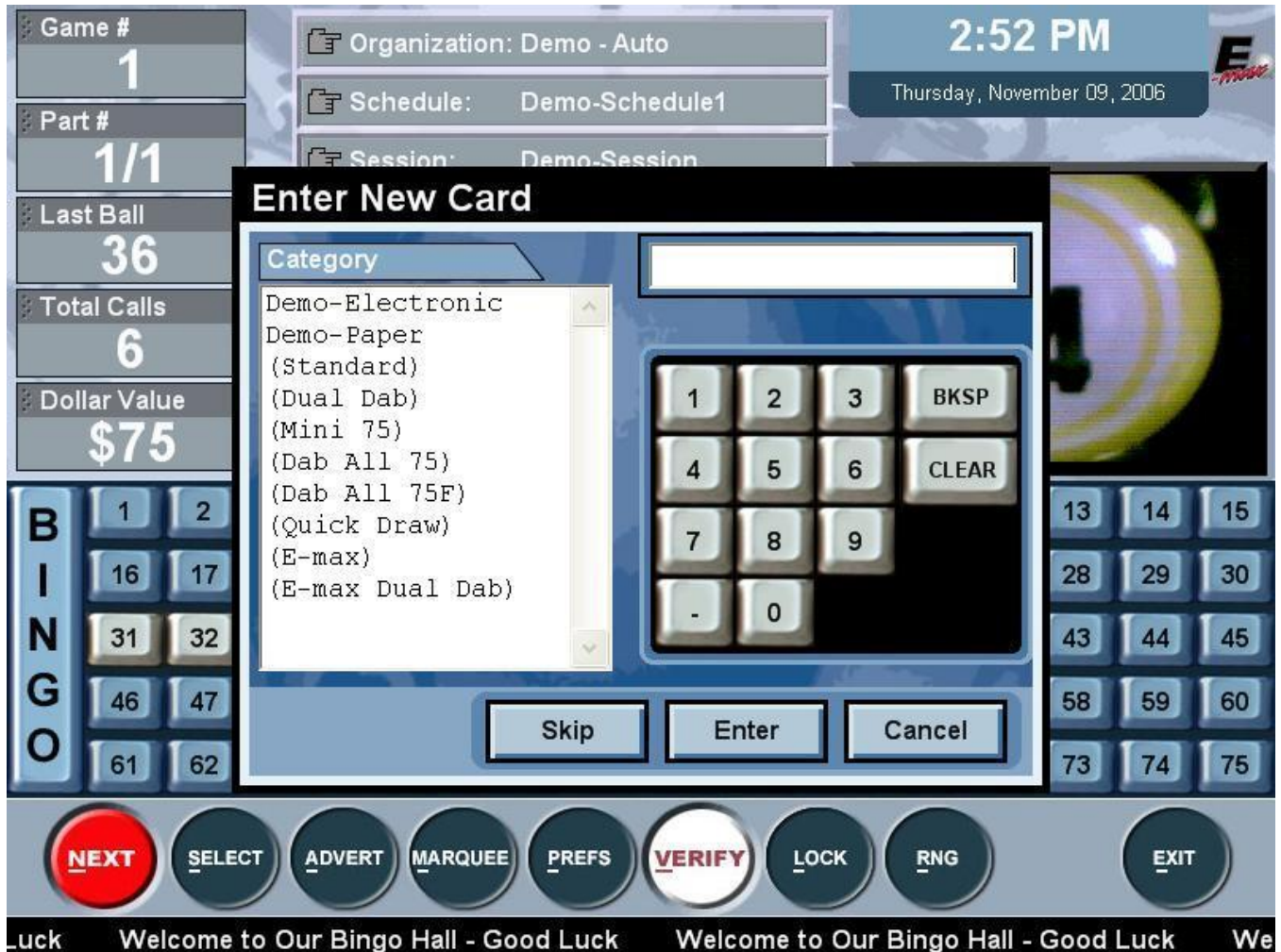

### Hot Key option:

You will notice that each button in the toolbar has the first letter underlined. The Console features a “hot key” function that allows the caller to press the first letter of the tool bar function on the keyboard instead of using the touch panel.

### NEXT button:

Will move you forward to the next game or the next part of the current game. It will become disabled and appear grayed out when you reach the last part of the last game in the schedule.

**SELECT button:**

Touching it brings up the **Game Selection** screen. This screen is a scrollable list of all the games in the schedule. The current game being played is displayed at the top of the screen. To change the current game, scroll the game you wish to play using the arrow buttons at the bottom of the screen, and select the desired game from the list.



**ADVERT button:**

Touching it brings up the Advertisements Selection screen. A list of available ads are at the top. Select the ad from the top list and the ad picture is shown in the middle of the screen. Press the **Right Arrow** button to test play the ad locally or the **PAUSE** button to stop it. If you wish to send the selected ad to the monitor hit the **SEND** button.



**MARQUEE button:**

This button brings up the **Marquee** screen. You can select an existing marquee, add a new marquee, edit an existing marquee, or delete a marquee.





Available, pre-made marquee messages are shown in the upper list at the top of the screen. At the lower portion of the screen is the list of marquee messages that are currently playing. To play additional messages, select each message from the top list and touch the down arrow to move it to the play list.

To stop a message that is currently playing, select the message in the play list and touch the up arrow to remove it from the play list.

Touching the **OK** button will accept any changes you have made to the play list and return you to the Live Game screen. Messages added to the play list will start scrolling, and any removed from the list will be removed from the scrolling marquee.

To add a new marquee, touch the **NEW** button, and enter your new message on the **Keyboard** screen. Touch the **OK** button to add the new marquee. To edit an existing marquee, touch the marquee in the top list you wish to edit. Next touch the **EDIT** button which will bring up the **Keyboard** screen. You may edit your marquee then touch **OK** to save your new marquee message. To delete a message, select it in the top list, and touch the **DELETE** button.

### **PREFS button:**

The **PREFS** button brings up the **Preferences** screen.

This button allows the operator to dynamically change certain functions during gaming. Select an item from the list on the left side of the screen.

### **Volume:**

Select the desired volume from the list and you will return to the **Live Game** screen.

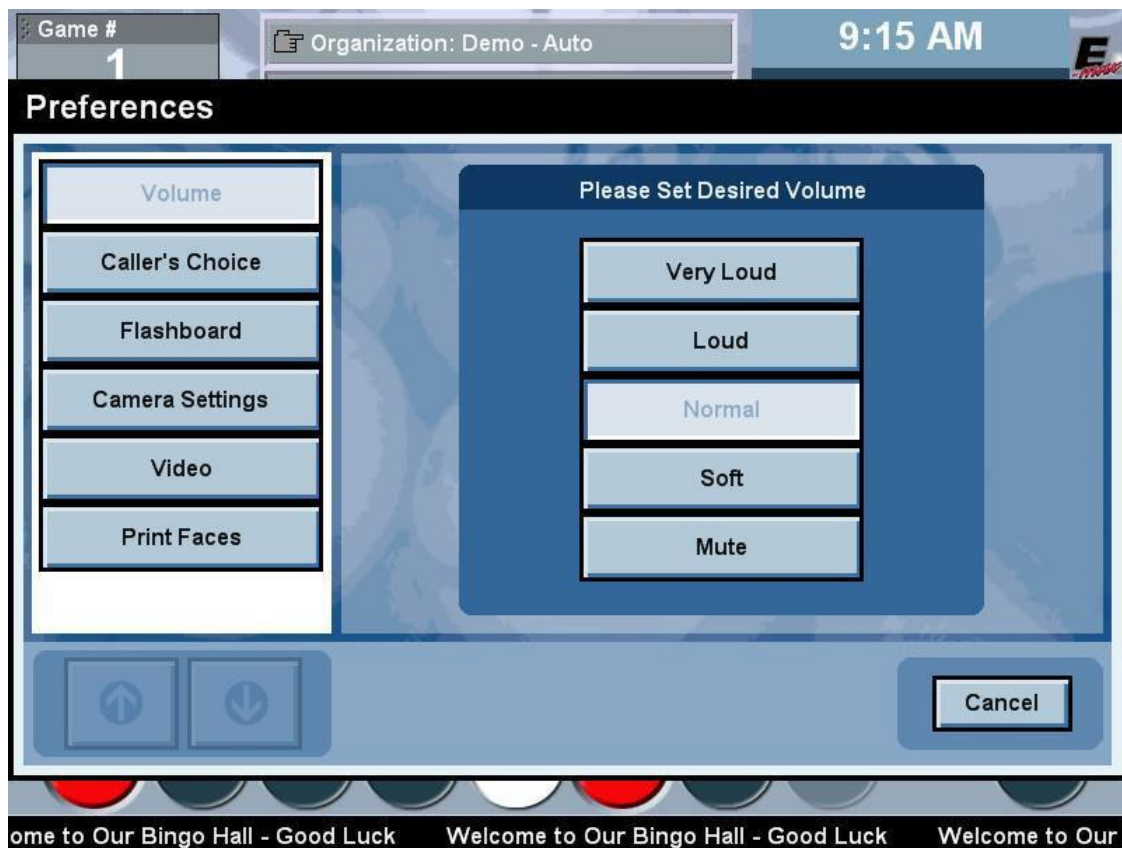

**Caller's Choice:**

Caller's choice should be executed at the beginning of a game prior to any balls being called. Two fields are editable- Payout amount and the pattern.

To adjust payout amount, touch the Payout field and enter a new value, then hit the **SAVE** button and you will return to the **Live Game** screen.

The pattern example shown below is a combined pattern of an **X**, an **L**, and a **T**.

To play one or more of the three patterns on the current game, select each pattern that you wish to play. The played pattern(s) will be only those highlighted in blue (**X** shown below). Hitting the **SAVE** button will transmit the new pattern (s) to the E-max gaming units and you will return to the **Live Game** screen.

Refer to **Chapter 6, SETUP, section 6.6**, the **SESSIONS** tab, **Delete Pattern** box. If this box is checked on, the winning pattern for this game will be automatically unselected for the next part of a multipart game. Occasionally, the last ball wins on two of the patterns simultaneously. Both patterns will be unselected. When all patterns have won, before all parts of a game have been completed, the console will always leave one of the patterns in play for the next part.

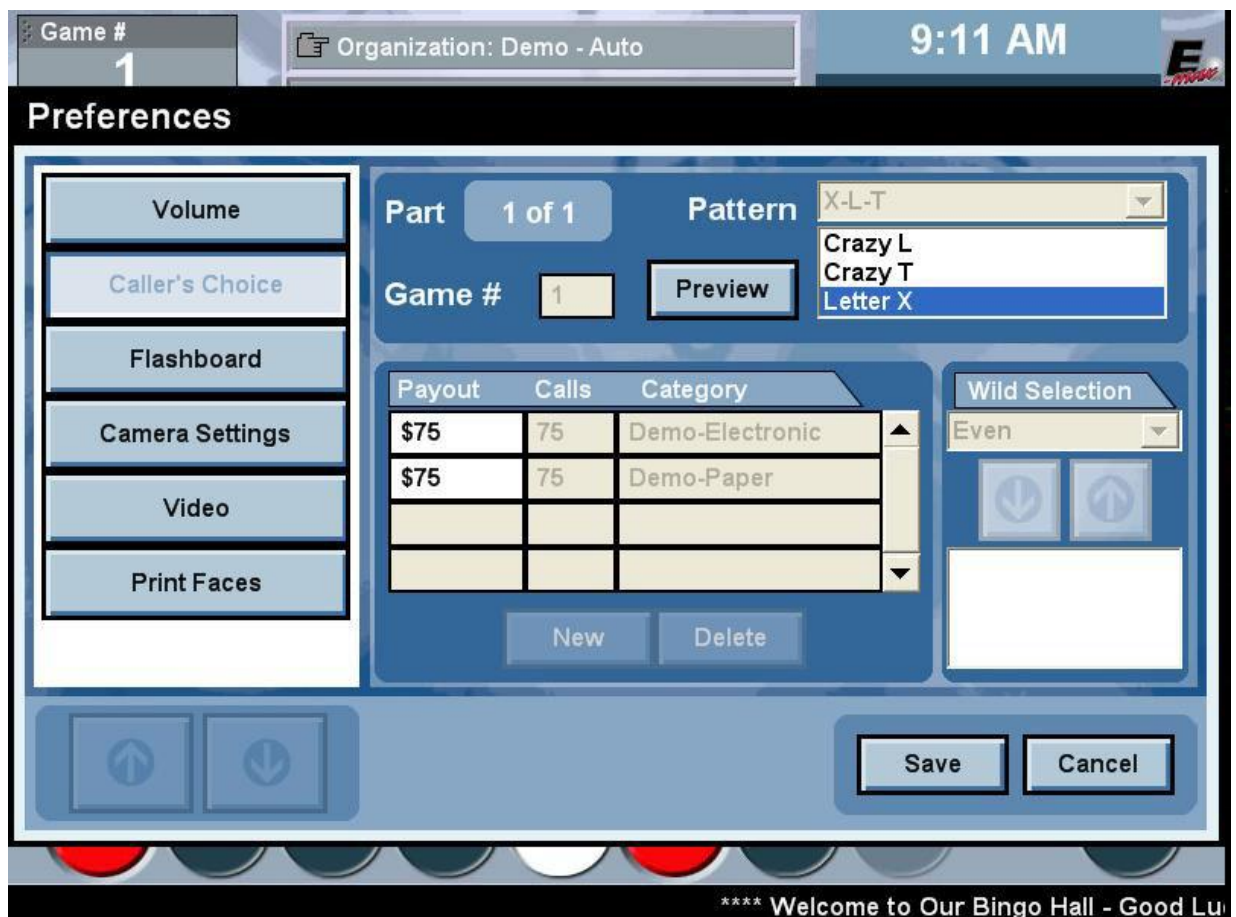

**Flashboard:**

Use the down arrows to display a list of items.

Choices for Game Pattern display digits on the flashboard are:

- Number of total calls
- Game Number
- Last Number

Choices for Dollar Value Numeric display digits on the flashboard are:

- Game Number
- Last Number

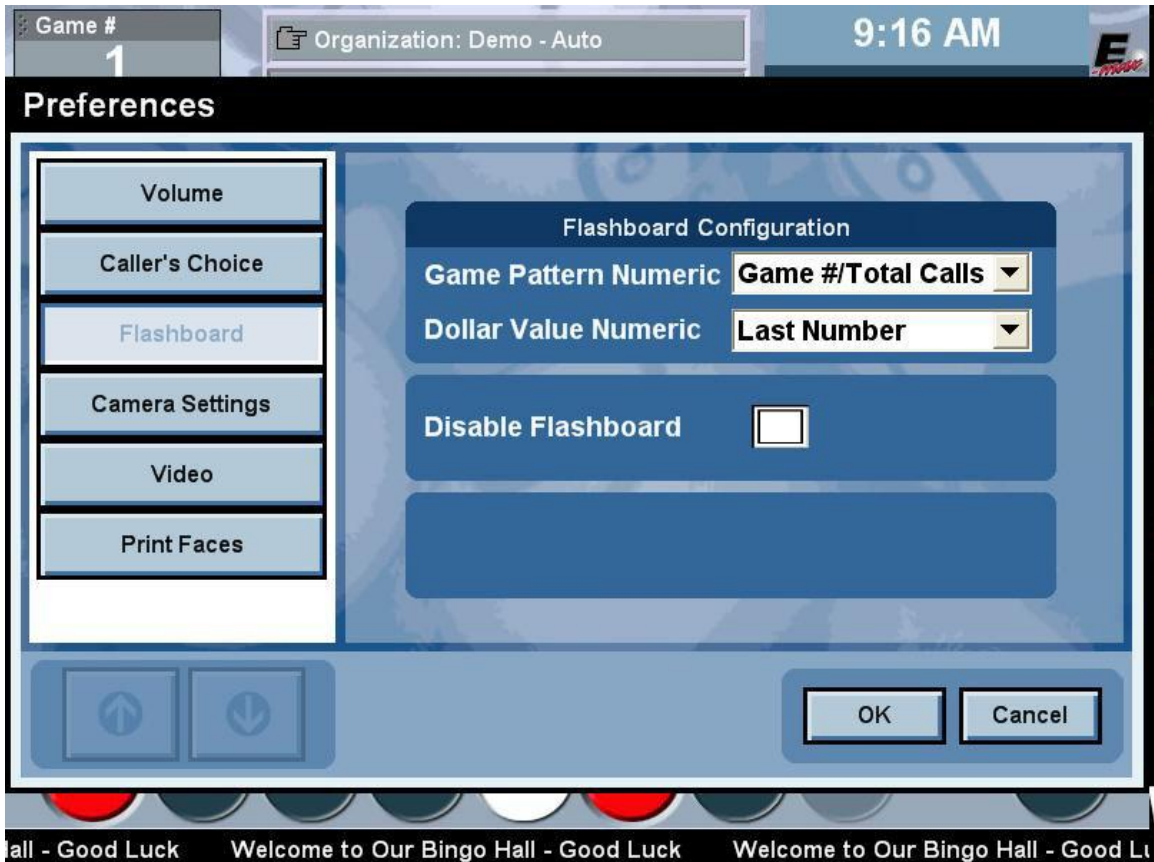

Select the desired feature from the list(s) and/or touch the **Disable Flashboard** box then hit **OK** and you will return to the **Live Game** screen.

**Camera Settings:**

Note that this function is for Consoles with two ball blower cabinets. It is not presented for the Express Bingo Console.

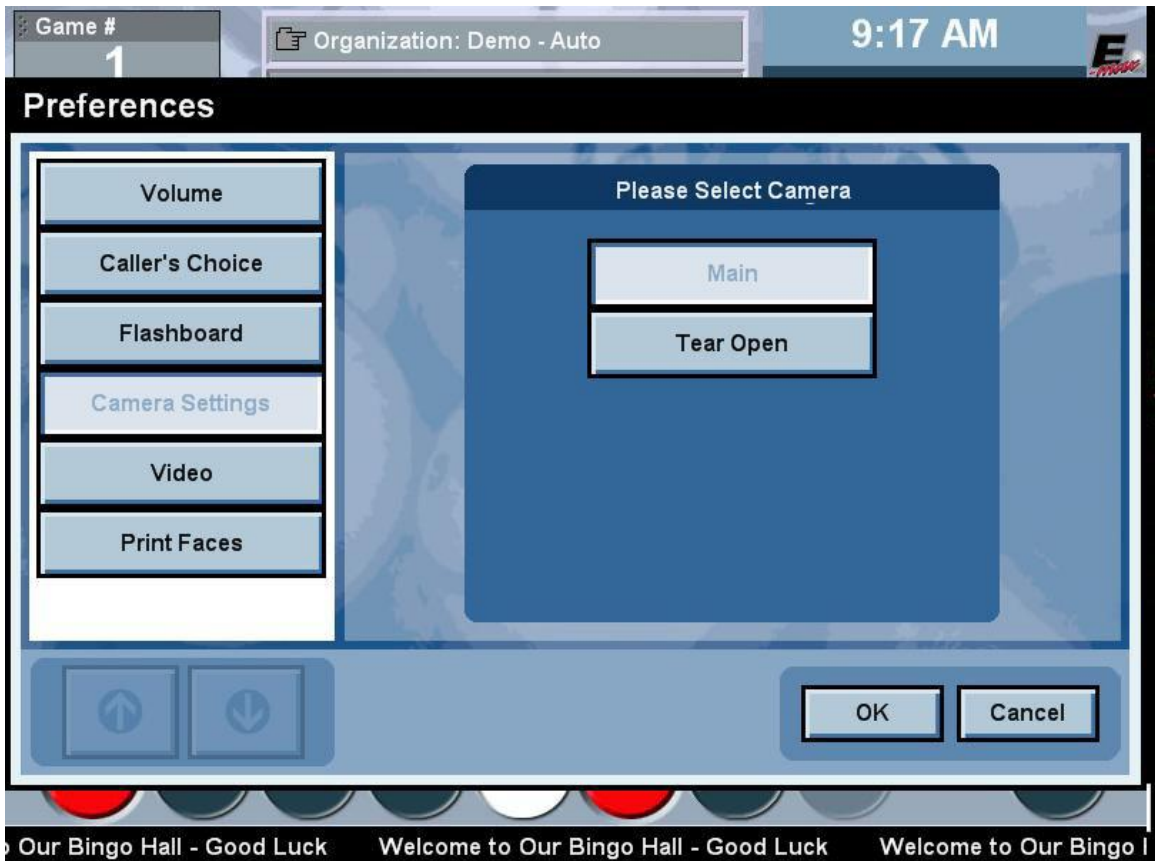

**Video:**

This causes an external RF video signal (like a TV feed) to replace the video ball image or video message image currently being displayed by the computer. The external video image will then show up on the hall monitors. The external video images must be connected to an RF modulator input. Note that the RF modulator is not supplied with the Express Console. If this feature is desired, the modulator should be externally wired to the Console.

Select external ball and/or external message video sources and hit **OK** to return to the **Live Game** screen.

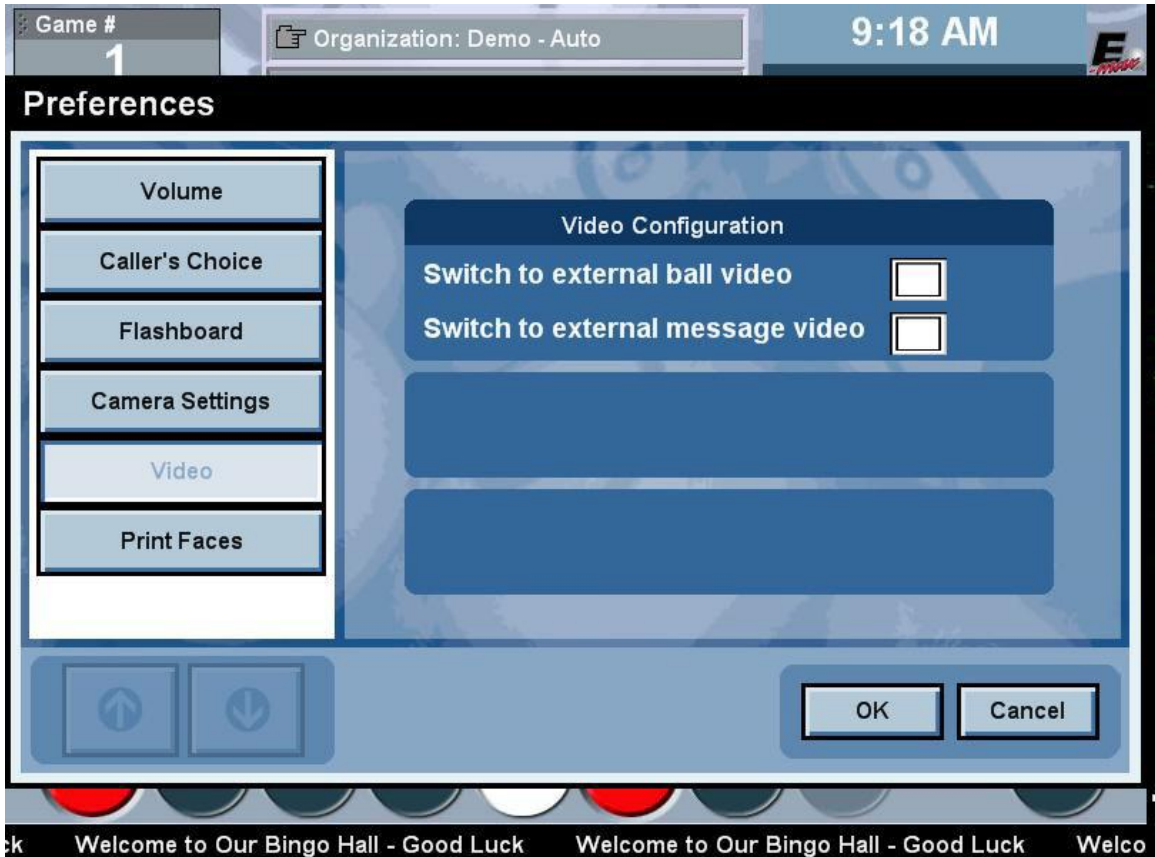

**Print Faces:**

Touch the box and input the free space number of a bingo card then hit **PRINT** to print the face on the printer. If the face does not exist in the current electronic Schedule, then an error message will appear. Just hit **OK** and then enter the correct free space number.

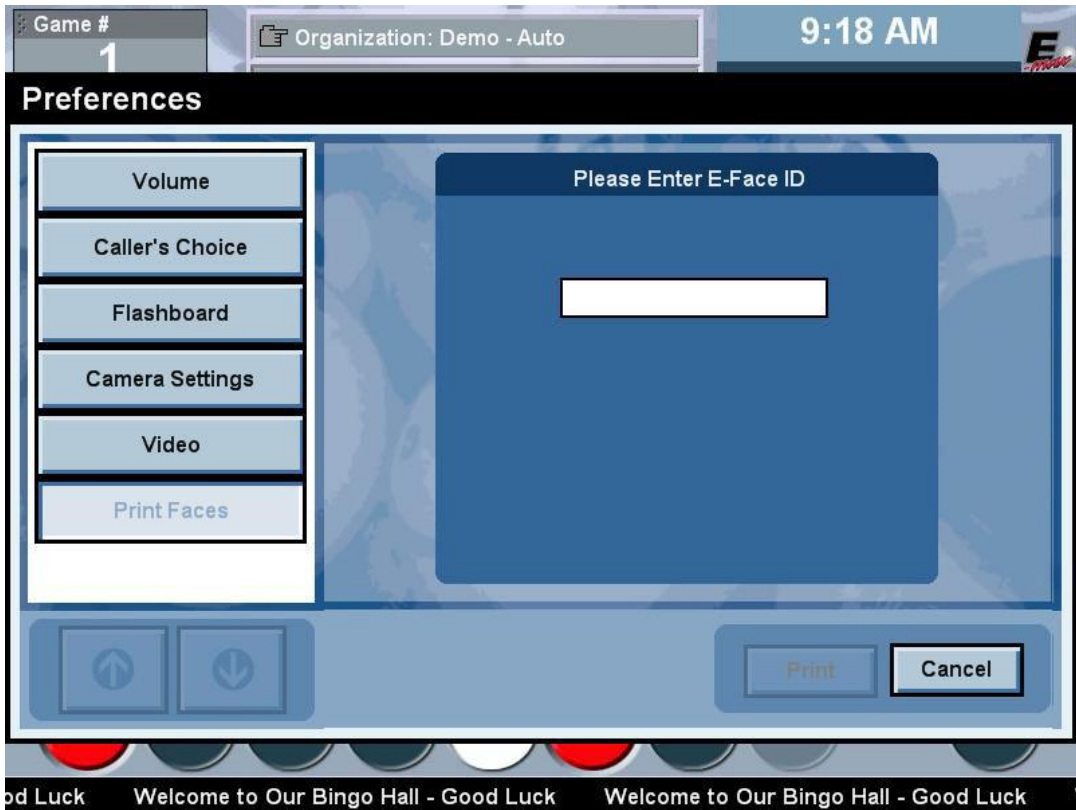

**VERIFY button:**

**Verify/Payout screen options not discussed in the QUICK TOUR:**

- If more than one winner exists, hit the **NEXT** button to enter in another card number to verify multiple winners.
- If you wish to change the preprogrammed payout amount, select the payout line to be changed and touch the **CHANGE** button. Enter the payout amount on the pop up keypad.
- If you wish to add a new payout, hit the **ADD** button and the payout amount will automatically be split evenly between the winners. Note that any payout entered from the Change function will only change the one payout selected and not the split.
- If you wish to remove a payout, select the desired payout line and touch the **REMOVE** button.
- Touch the **SAVE** button to save the payouts and take you back to the **Live Game** screen without advancing the session to the next game.
- You can also remove the winning cards from progressive games.
- The Serial number window on the right hand side of the screen allows you to enter the serial numbers of the books sold for your session. This adds another dimension to game security and integrity.

**Verify / Payout**

Game # 1  
Part # 1/1  
Last Ball 35  
Total Calls 5  
Dollar Value \$75

(Standard)				
B	I	N	G	O
1	16	31	46	65
5	17	33	47	64
3	18	Free 34	49	63
4	19	34	48	62
2	20	35	50	61

Serial # 0

#	Category	Card#	Payout
1	(Standard)	34	\$50.00

Winner 34

Buttons: Next, Add, Remove, Change, Done, Save, Cancel

Good Luck Welcome to Our Bingo Hall - Good Luck Welcome to Our Bingo Hall - Good Luck

**LOCK button:**

This button secures the Console and prevents any changes during gaming if the operator must momentarily leave the Console. Pressing this button places you at the **Log In** screen. You must swipe your card and enter a password (if needed) to return to the **Live Game** screen.

**EXIT button:**

This button returns you to the **Main Menu** screen.

**Caution: Hitting Exit during gaming and then re-entering gaming with Play on a multi-part game that had a console's auto deletion of a pattern or a caller's choice manual deletion of a pattern, will result in the original pre-programmed patterns re-appearing. The deleted pattern will be present again.**

With an understanding of Console functions, it is now time to set up your Organization with the controls provided under the **SETUP** button on the **Main Menu** screen.



## 6.0 Setup

The Console is very flexible in its ability to change its operational characteristics to meet the needs of your organization. The downside of good flexibility is that there are many parameters that need to be defined.

**The Console is integrated with the POS and Load & Track products and therefore, must be setup in conjunction with them. The *order* in which each product is setup is *very important*. Please review Chapters 6 and 7 before attempting to setup your particular system.**

Also use the **DEMO** documentation stored under the **Help** screen as a guideline in defining your system.

### **Architecture for the Console, POS, and Load & Track products:**

The two following block diagrams define the internal architecture and the order of hierarchy for functional elements within the Console, POS, and Load & Track products. The products support single level setup of the functional elements to meet the needs of your small organization and also multiple levels of the functions for a large commercial hall. The diagrams also provide you with terminology that will be used in the description of the setup of the system.

After a quick glance of the architecture, you will be guided step by step in the simple use of each setup screen.

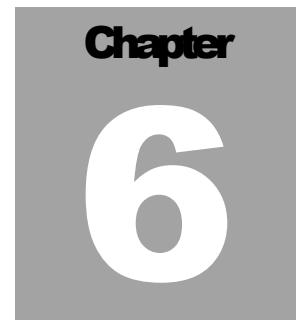

# E-MAX CONSOLE HIERARCHY

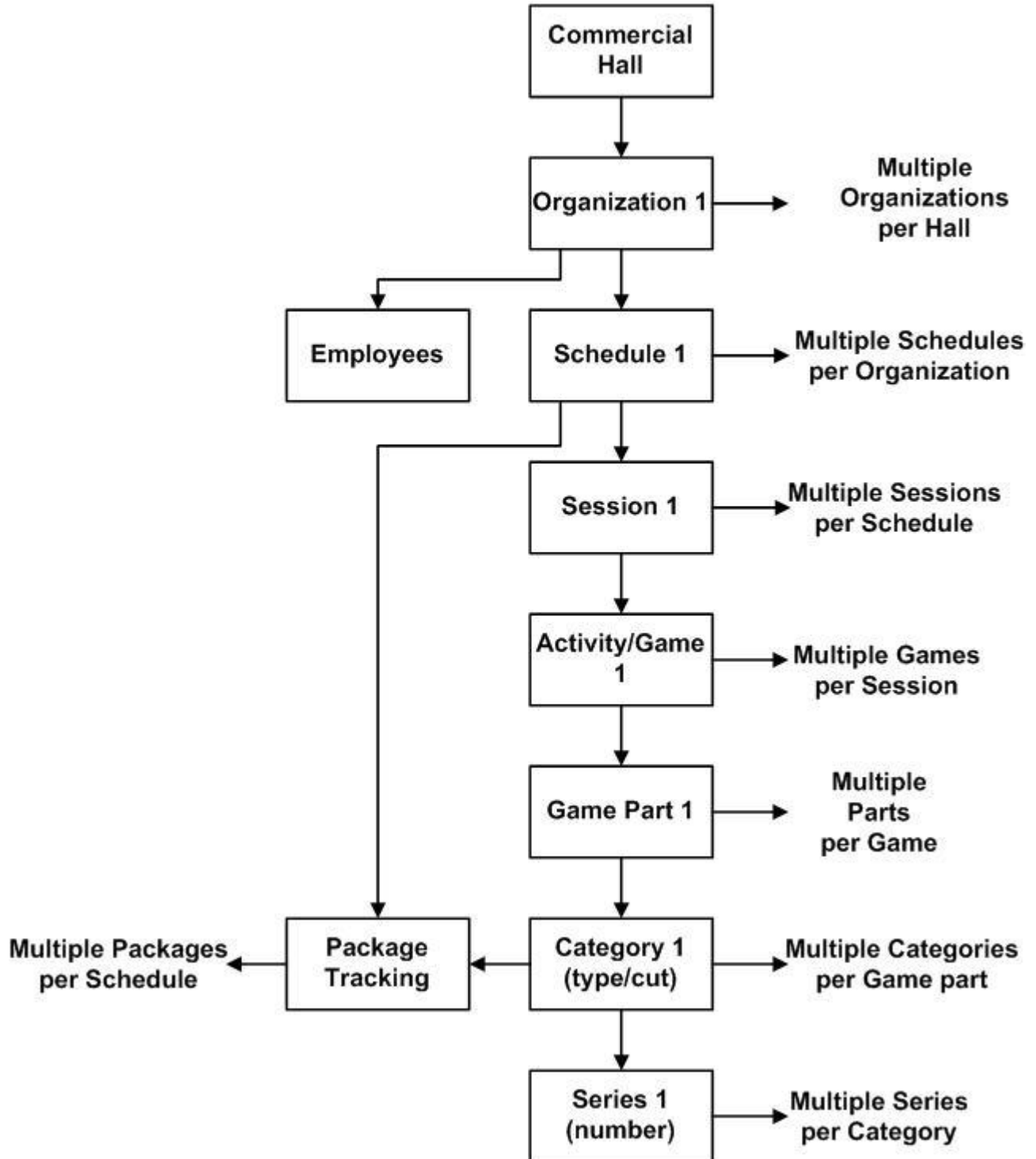

## E-MAX POS HIERARCHY

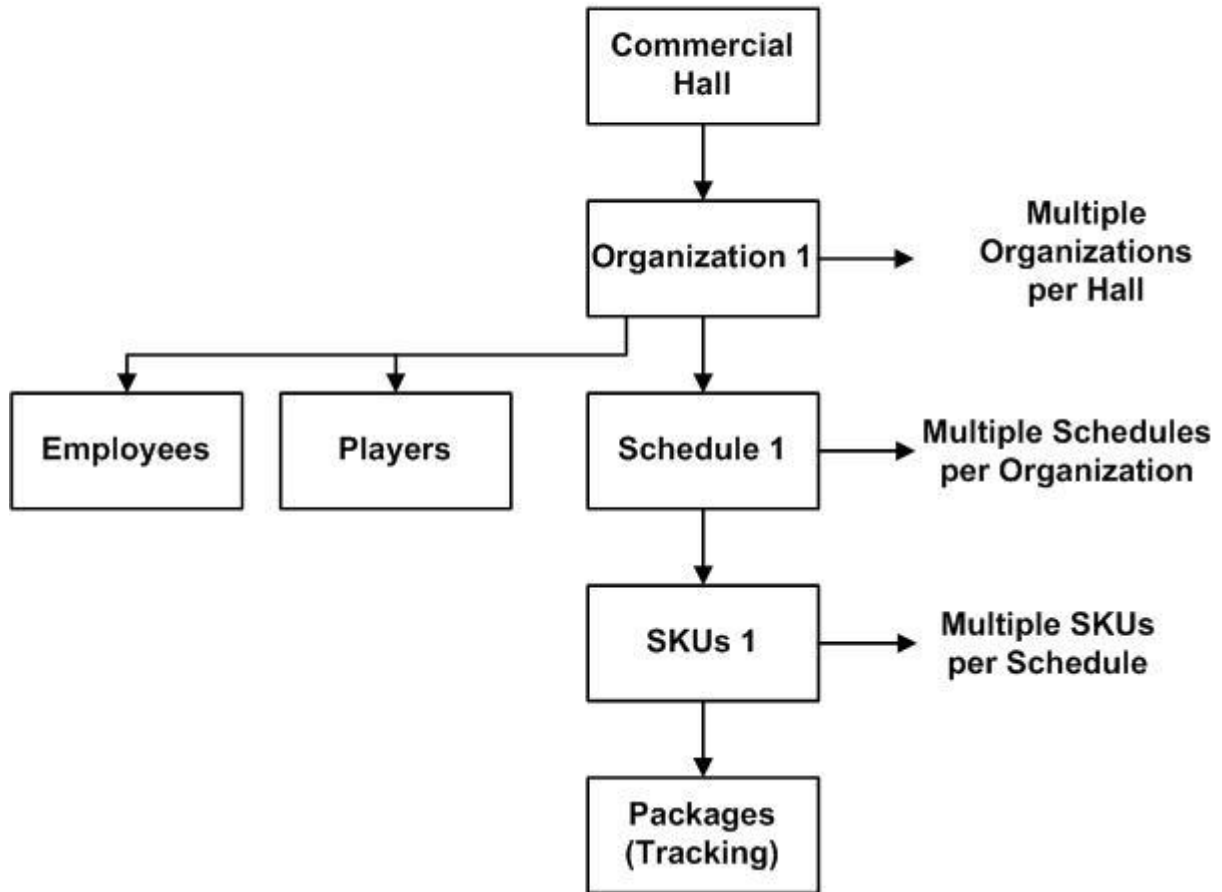

**ALL OF THE FOLLOWING CONSOLE SETUP ITEMS MUST BE COMPLETED, IN ORDER, AND PRIOR TO SETTING UP THE POS OR LOAD & TRACK PRODUCTS.**

Console Main Menu buttons and sub buttons in order of their use:

**SETUP:**

- Organization (One or more per hall)
- Category (Specify permutation, paper, and electronics, to be used)
- Optional Advertisements (Define custom Text ads)
- Optional Marquee (Define custom text message that scrolls on the hall monitors)
- Optional Pattern (Define custom winning game patterns)
- Session (Create Activities, Games, include optional ads and Marquees)
- Schedule (Join multiple Sessions together)
- Package (Combine multiple Categories, assign a specific name, and attach to a Schedule)

**UTILITIES:**

- User/Group Security (Employee setup of names and passwords)

The following sections of this chapter will walk you through the setup of the Console. After completing Chapter 6, Chapter 7 will guide you through the Utilities security setup.

## 6.1 Organization

Touch the **SETUP** button from the **Main Menu**. The **Organization** screen is displayed.

**ORGANIZATION tab:** (Can have one or more organizations per hall)

You can edit an existing Organization (if present) to create a new Organization by selecting the organization from the list on the left side of the screen, then hit the **EDIT** button. For now, we will proceed with the setup of a new Organization.

Touch the **NEW** button.

A pop up keyboard will appear. Enter the name of the new organization (15 characters or less is ideal).

At the top of the screen, touch each white box and fill in the Address, City, State, ZIP, Phone number, Fax number, and Organization License Number. **The license number is important since it shows up in financial and regulatory reports.**

**GENERAL tab:** (Console gaming operations)

**Verification** – select how the game is to be played, with or without the last ball determining a valid win

**Marquee speed**- select the rate at which the message scrolls across the monitors and blinks on the E-max

**Ask to log** – Leave this box unchecked (**highly recommended**) if you wish to automatically save all gaming data when the Schedule is deactivated. Checking this box will provide the operator with a prompt to Save or discard the gaming data upon Schedule deactivation (prone to wrong responses to the prompt).

**Round payout** – Select the direction to round up or down and the amount to round to. Typically \$1, rounded up is used.

**Single win** – Checking this box will cause a single payout to be made if there are multiple winning patterns on a single face.

**Auto search**- Checking this box (recommended) enables auto searching through all perms to find the winning card.

**RNG** – Checking this box (**may be prohibited by regulations**) enables the random number generator for ball calling. The **RNG** button on the toolbar becomes active.

**Callers choice**- Check this box on to enable the callers choice screen under **PREFERENCES** on the toolbar. For electronics, the choices are limited to only the pattern and the payout amount.

**Number parts**- Checking this box on (recommended) will automatically number multiple parts of a game. This feature allows the creation of progressive or multiple part games

**Camera Monitor**- Only a single choice is available

**Show Marquee**- Check this box if you wish to have the marquee show up at the bottom of the ball camera monitor

**Message Monitor**- not available on the Express Console

**Show Marquee**- Check this box if you wish to have the marquee show up at the bottom of the message monitor

**Game Pattern Numeric**- Choose what to display in the numeric digit position of the flashboard (flashboard types vary)- (Game Number, Last number, or Total calls)

**Dollar Value Numeric** - Choose what to display in the dollar value digit position of the flashboard (flashboard types vary)- (Game Number, Last number)

## E-MAX SETTINGS tab: (E-max gaming unit operations)

When the Console communicates with the E-max gaming unit, it passes the following settings to it before bingo gaming starts. One setup on the Console quickly services many E-max units rather than trying to manually setup each E-max unit.

Touch the **E-max Settings** tab.

The screenshot displays the 'Organization' settings screen. On the left, a sidebar shows 'Selected Organization' as '\*\*\* NONE \*\*\*' and a list of 'Organizations' including 'Demo - Auto' (selected), 'Demo - Manual', 'Demo - Paper', and 'Demo - Semi-Auto'. The main area is titled 'Organization' and contains several input fields: Name (New Organization), PH. #, Addr (123 Road), Fax #, another Addr field, LIC. # (q123), City (Here), ST (MD), and ZIP (44444). Below these are two tabs: 'General' and 'E-max Settings'. The 'E-max Settings' tab is active and contains: Default Theme (None), Default Dauber (3D Smiley), Play Mode (Auto), Backlight (75%), Default Volume (Normal), Win Sound (checked), E-max Pwd (empty), Win Light (checked), Max Cards (100), Same Cards (checked), Pack Expiration (20 Hrs), Routed Units (unchecked), Default Birthday (None), Days To Ack (0), and Default Anniversary (None). At the bottom, there are buttons for 'NEW', 'EDIT', 'DELETE', 'SAVE', 'SAVE AS', and 'CANCEL'. A footer line reads '(c) 2005 E-max Gaming Corporation, Inc. v2.0.72.0'. At the very bottom, a navigation bar includes buttons for 'Organization', 'Schedule', 'Session', 'Category', 'Pattern', 'Advert', 'Marquee', 'Package', 'Revenue', and 'Exit'.

**Default Theme-** The E-max unit has various graphical themes such as Elvis and Betty Boop that can be loaded onto the unit. Choose from the pull down list the theme that will be displayed when the E-max gaming screen first appears. The item in the list labeled Default is the EGC factory default image.

**Default Dauber-** Choose from the list the dauber that will be displayed when the E-max unit gaming screen first appears. The theme selected above carries a default dauber with the theme.

**Play Mode-** The E-max system supports three modes of daubing – Auto, Semi-Auto, and Manual. Auto mode daubs the ball automatically via the RF network. Semi-Auto mode sends the ball via the RF network, but the player must touch the E-max unit to acknowledge the ball number. Manual mode means the player must manually key every ball called into the E-max unit. **Not all States allow all of these modes of play. Regulations may limit the selection list or force it to play in only one mode.** If available, choose one of the E-max modes of play from the list.

**Backlight-** For the first software release, the backlight is fixed to 75% brightness.

**Default Volume-** You can specify how loud the E-max speaker audio is allowed to be. The player can adjust the volume on the E-max only in a downwards direction from what you specify. Choose one of the settings from the list. (Mute, Soft, Normal, Loud, Very Loud)

**Win Sound-** When the E-max detects a winning card, it displays a **Win** screen and plays a tune if this box is checked on. If not checked, the audio is inhibited on the **Win** screen. **State regulations may govern the use of sound.**

**Win Light-** When the E-max detects a winning card, it blinks the dome green LEDs if this box is checked on. If not checked, the LEDs will remain off. **State regulations may govern the use of a win light.**

**E-max Password-** This is a password for use by the person assigned to the E-max Support Manager magnetic card. The purpose of the manager is to support players on the floor with E-max issues, review management screens on the E-max to resolve issues, and also manually delete the gaming package on the E-max for voids or reloads (See POS and Load & Track documentation). Enter the manager password on the pop up keypad.

**Max Cards-** This number represents the maximum number of cards that can be loaded onto a single E-max. **The maximum value is generally defined by State regulations and you will not be able to enter a number larger than allowed.** However, if you choose, you can enter a smaller number. **Note that if you enter zero, then the E-max setup is not valid and the E-max will not load any packages.**

**Same Cards-** Checking this box on will load the same set of card faces into the E-max for every game in the Schedule. Not checking will load different cards for each game.

**Pack Expiration-** This is the number of hours from the activation of the Schedule that the E-max unit will **automatically** delete any gaming package that was loaded for the Schedule. **MAKE SURE THE NUMBER IS LARGE ENOUGH TO FINISH YOUR SCHEDULE!! State regulations may specify a maximum value.**

**Routed Units-** If this box is checked the E-max unit is setup for routing. This means that if the E-max keyboard or base is placed in the transport position (folded up) with a gaming package loaded, the package will be automatically deleted in approximately 10 minutes. If the box is left unchecked, the E-max is being used in a stationary application and it will not delete the gaming package in the transport position.

**Default Birthday-** If player tracking is used, the system has the ability to display a birthday image on the E-max unit for that particular player on their birthday. Several birthday images are available. Choose from the list the image that will be displayed.

**Default Anniversary-** If player tracking is used, the system has the ability to display an anniversary image on the E-max unit for that particular player on their anniversary. Several anniversary images are available. Choose from the list the image that will be displayed.

**Days to Acknowledge-** The player may not play bingo on the exact day of his birthday or anniversary. The number you enter is a window (in days) before or after his birthday or anniversary that the special image will appear. The special image appears only once in that window of time and will not appear again until next year.

**Hit the SAVE button.**



## 6.2 Category

**CATEGORY** tab: (Specify permutation, paper, and electronics, to be used)

**Typically, if you are playing paper and electronics, you need to define a Paper Category and an Electronic Category that do not have the same series of faces.** It is helpful to denote in the Category name that you use whether the category is for paper (P) or electronic (E). If the number of faces per game vary (tear open or fast call are typically only a few faces), then you need to define a Category for each such that the number of faces can be defined differently for each.

Touch the **Category** tab at the bottom of the screen.

The screenshot displays the 'Category' configuration interface. On the left, the 'Selected Organization' is 'Demo - Auto'. Below it, a list of categories is shown, including 'Demo - Dual Dab E', 'Demo - Dual Dab P', 'Demo -Tear Open E', 'Demo -Tear Open P', 'Demo-Electronic', 'Demo-Electronic2', and 'Demo-Paper'. The main 'Category' section includes the following fields and controls:

- Name:** An empty text input field.
- Description:** An empty text input field.
- Card Type:** A dropdown menu currently set to 'Dab All 75'.
- Cut:** A dropdown menu currently set to '3 ON V'.
- Category Type:** A dropdown menu currently set to 'Electronic'.
- Series:** A list of empty rows for defining series, with 'NEW' and 'DELETE' buttons below it.

At the bottom of the screen, there are navigation buttons: 'NEW', 'EDIT', and 'DELETE' on the left; 'SAVE', 'SAVE AS', and 'CANCEL' on the right. A copyright notice '(c) 2005 E-max Gaming Corporation, Inc., v2.0.72.0' is located above the bottom navigation bar. The bottom navigation bar contains tabs for 'Organization', 'Schedule', 'Session', 'Category', 'Pattern', 'Advert', 'Marquee', 'Package', 'Revenue', and 'Exit'.

Touch the **NEW** button.

**Name-** A pop up keyboard will appear. Enter the name of the new Category (15 characters or less is ideal)

**Description-** Enter a description for the Category

**Card type-** Choose from the list of available card types

**Cut-** Choose the ON cut from the list.

**Category type-** Choose paper or electronic

**Series-**

Hit the **NEW** button then touch the entry that pops up in the screen.

Choose the desired series from the pull down list that is displayed

Hit the **NEW** button again and repeat above to enter another series

Provide enough series of faces to support the sales of Max Cards allowed, adjust for Same Cards being checked or not, and anticipate the maximum expected number of E-max units being played for the Schedule.

**Hit the SAVE button.**

## 6.3 Advertisements

**ADVERTISEMENT** tab: (Define custom Text ads)

There are two types of basic ads- Text and Graphical.

Only Text ads can be entered directly into the Console during setup.

Graphical ads, with or without sound track, must be pre-loaded onto a CD and then loaded on the Console using the **Upgrade Software** button under **Utilities** on the **Main Menu** screen. Once loaded, they will automatically show up in a list during the setup process. They can not be edited, just viewed.

Creating an ad in the setup process is optional. You can come back later, make a Text ad and insert it into a Session by using the **ADVERT** tab and then the **SESSION** tab.



To enter a Text ad:

Touch the **NEW** button.

**Name-** A pop up keyboard will appear. Enter the name of the new Text ad (15 characters or less is ideal)

**Description-** Enter a description for the ad

**Duration-** Enter a duration value in seconds for the ad to run

Enter the text message one line at a time. Each line can have a maximum of 25 characters

To view a graphics ad:

Touch the desired ad in the list on the left side of the screen.

## 6.4 Marquee

**MARQUEE** tab: (Define a custom text message that scrolls on the hall monitors)

Creating a marquee in the setup process is optional. You can come back later, make a marquee and insert it by using the **MARQUEE** tab and then the **SESSION** tab.

The screenshot shows a software interface for creating a marquee. On the left, a sidebar contains a 'Selected Organization' dropdown set to 'Demo - Auto' and a 'Marquees' list with 'Demo-Marquee' selected. Below the list are 'NEW', 'EDIT', and 'DELETE' buttons. The main area is titled 'Marquee' and contains a 'Name' field with 'Demo-Marquee', a 'Text' field with 'Welcome to Our Bingo Hall - Good L', and a checked 'Show On E-max' checkbox. At the bottom of the main area are 'SAVE', 'SAVE AS', and 'CANCEL' buttons. A copyright notice '(c) 2005 E-max Gaming Corporation, Inc. v2.0.72.0' is visible. A navigation bar at the very bottom includes buttons for 'Organization', 'Schedule', 'Session', 'Category', 'Pattern', 'Advert', 'Marquee', 'Package', 'Revenue', and 'Exit'.

Enter a text message to be scrolled:

Touch the **NEW** button.

**Name-** A pop up keyboard will appear. Enter the name of the new Marquee (15 characters or less is ideal)

**Text-** Enter the text message to be scrolled. A maximum of 80 characters can be shown on the E-max, longer messages on the monitors.

**Show on E-max-** Check this box to enable the marquee on the E-max. If the message is longer than 80 characters, it will be truncated.

## 6.5 Pattern

**PATTERN** tab: (Define custom winning game patterns)

The Console has a very large number of pre-built patterns to choose from. If these standard Patterns are acceptable for your Schedule(s) than you can skip this setup procedure. Proceed to building a **Session**.

To view a standard Pattern:

Select the Pattern from the list on the left side of the screen

The name of the highlighted pattern and its description appears in the **Name** and **Description** fields and Pattern combinations appear on the right side of the screen. The Number of Combinations is also displayed.

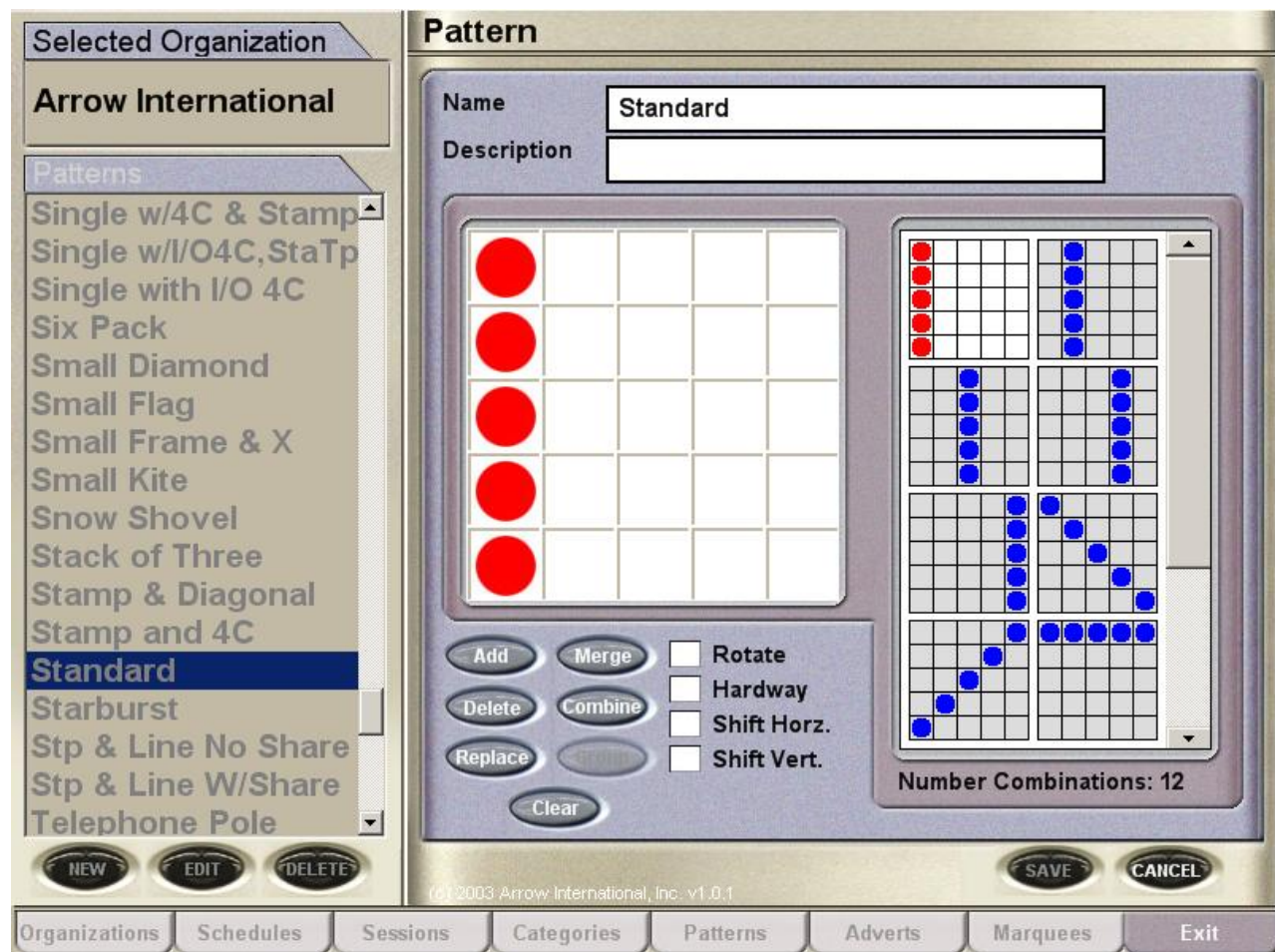

To  
crea  
te a

custom Pattern:

Touch the **NEW** button.

**Name**- A pop up keyboard will appear. Enter the name of the new Pattern (15 characters or less is ideal)

**Description**- Enter a description for the Pattern

You can make a custom Pattern from scratch or use a standard Pattern as a starting point and modify it. You can also combine any number of programmed Patterns to create multiple bingo Patterns. The following definitions will help you understand some terminology.

**Touching** – patterns are next to but do not share any cells.

Any Line with Block of 4.

O				
	O			
		O		
O	O		O	
O	O			O

**Sharing** – share one and only one cell between patterns.

Any Line with Block of 4.

O				
	O			
		O		
		O	O	
		O	O	O

**Overlap** – must share two or more cells between patterns.

Any Line with Block of 4.

O				
	O			
		O	O	
		O	O	
				O

**Separate** – have one or more cells between patterns.

Any Line with Block of 4.

			O	
			O	
			O	
O	O		O	
O	O		O	

**Options:**

Touch – True  
 Share – False  
 Overlap – False  
**Definition:** Patterns must be next to but do not share any cells.

Touch – False  
 Share – True  
 Overlap – False  
**Definition:** Patterns must share one and only one cell between patterns.

Touch – False  
 Share – False  
 Overlap – True  
**Definition:** Patterns must share two or more cells between patterns.

Touch – True  
 Share – True  
 Overlap – False  
**Definition:** Patterns that are next to but do not share any cells and patterns that share one and only one cell.

Touch – True  
Share – False  
Overlap – True

**Definition:** Patterns that are next to but do not share any cells and patterns that share two or more cells.

Touch – False  
Share – True  
Overlap – True

**Definition:** Patterns that share one or more cells.

Touch – False  
Share – False  
Overlap – False

**Definition:** Patterns with one or more cells are between patterns.

Other functions to aid you in generating a pattern:

Add-  
Merge-  
Continue-  
Group-  
Rotate-  
Hardway-  
Shift Horizontal-  
Shift Vertical-



## 6.6 Session

**SESSION** tab: (Create Games and Activities)

A **Session** is a collection of several **Activities**- one of which is a Game, another is an Intermission. The Games can have one or more Parts. You are going to create the first Activity and then repeat the process creating additional Activities until the desired Session is completed. The Activities are sequentially numbered as you complete them.

Touch the **SESSION** tab at the bottom of the screen.

Touch the **NEW** button.

**Name-** A pop up keyboard will appear. Enter the name of the new Session (15 characters or less is ideal)

**Description-** Enter a description for the Session

**Activity-**

**Name-** Touch the Name box and enter the name of the Activity

**Color-** Choose the desired border color for the displayed bingo card face from the pull down list

**Advertisement-** Choose one of the existing Text or Graphical ads shown in the pull down list or skip this step if you have not made any ads.

**Marquee-** Choose one of the existing marques shown in the pull down list or skip this step if you have not made any marquees.

**Intermission-** Check this box if an Intermission Activity is desired. The screen on the Console and the hall monitors will display a count down timer. The screen on the E-max unit will display a static, graphical intermission image.

**Timer-** If the Intermission box was not checked, skip this setup procedure, otherwise, enter the intermission count down timer value in minutes. When the timer reaches zero, it will flash red on the Console and hall monitors. You do not need to complete the rest of this setup procedure. Go directly to **Hit the Save** button below.

**Game-** Always check this box unless the Activity is an Intermission.

**Delete Pattern-** For multipart games, checking this box will automatically delete the last winning pattern before the start of the next part of the game. This eliminates re-winning on the same card face when advancing to the next part.

**Bingo FB-** Check the box if you want the called balls to be displayed on the main Bingo flashboard(s)

**Tear Open FB -** Check the box if you want the called balls to be displayed on the Tear Open flashboard(s)

**Disable FB-** Check this box if the Activity is a fast ball game and no called balls are to be displayed on the flashboard(s)

**Tray, Main-** For the single blower Express Console, it will always be checked.

**Tray, Tear Open-** For a single blower Console this box will be grayed out.

**Paper-** Select from the pull down list the type of boarder for the paper to be displayed

**Color-** Select from the pull down list the color of boarder for the paper to be displayed

You have now completed the general portion of the Activity. You must now specify the details of the **Part** of the Game Activity. Remember that a single Game can have multiple **Parts**.

#### **Part-**

**Pattern-** Select the desired winning pattern from the pull down list. If the pattern is not present and you want to create a new one, for now, select one of the standard patterns and continue with setup. You can come back later and select the new pattern that you created.

**Timer-** Enter the value of the ball count down timer in seconds

**Game Number -** Enter the Game number that is displayed on the flashboard and the E-max screen

**Wild Number-** If a wild number function is desired for this Part, select the type of wild number from the pull down list. Then hit the **ADD** button to include it.

**Payout-** Enter the amount for the payout.

**Calls-** Enter, in association with the **Payout** amount, the required number of balls called to achieve the payout. Several tiers of **Payout/Calls** can be entered for each Category.

**Category-** Select one from the pull down list of available Categories. For each tier of **Payout/Calls**, select the same Category. Multiple Categories with multiple tiers within each category can be entered such as three tiers of Payout/Calls for a Paper Category and the same three tiers of Payout/Calls for an Electronics Category.

**Hit the SAVE button.**

You have now completed a single Activity containing a single Part.

You must now go back in and **EDIT** the new Session and add more Parts per Activity and then new Activities until the entire Session is completed. Hitting the **Save** button after each Activity is a precautionary step. If you feel confident about not losing data, do not hit **Save** and complete all Activities in the Session, then hit **Save**.

**EDIT** the Session or adding more Activities and Parts:

If you want to add more **Parts** to an Activity, do it first before creating a new Activity:

Go to the **Part** portion of the screen, hit the **NEW** button. A pop up keyboard will appear. Enter the name of the new **Part** and repeat the **Part** procedure described above.

After entering all Parts, you can add new **Activities**:

Go to the **Activity** portion of the screen, hit the **NEW** button. A pop up keyboard will appear. Enter the name of the new **Activity** and repeat the **Activity** procedure described above.

When completed with all Activities and all Parts, **Hit the SAVE button.**

You have now completed a Session.

If you wish to play multiple Sessions per Schedule, such as Early Bird Session then a Regular Session, you must go back and create the additional Sessions **BEFORE** proceeding to the following **Schedule** setup procedure.

## 6.7 Schedule

**SCHEDULE** tab: (Join multiple Sessions together)

A Schedule joins Sessions together to complete the full night of bingo entertainment. Typically a hall may have an Early Bird Session, a Regular Session, and a Late Session. For instance, those Sessions can be combined into a Schedule named Saturday.

Touch the **SCHEDULE** tab at the bottom of the screen.

The screenshot displays the 'Schedule' management screen. On the left, a sidebar shows the 'Selected Organization' as 'Demo - Auto' and a list of 'Schedules' with 'Demo-Schedule1' selected. The main area has input fields for 'Name' (filled with 'Demo-Schedule1'), 'Description', and 'Play Duration' (set to '1' hours). Below these are two columns: 'Available' (containing 'Demo - Early Bird') and 'Selected' (containing 'Demo-Session'). Navigation arrows are between the columns. At the bottom are buttons for 'NEW', 'EDIT', 'DELETE', 'SAVE', 'SAVE AS', and 'CANCEL'. A footer bar contains tabs for 'Organization', 'Schedule', 'Session', 'Category', 'Pattern', 'Advert', 'Marquee', 'Package', 'Revenue', and 'Exit'. Copyright text '(c) 2005 E-max Gaming Corporation, Inc. v2.0.72.0' is visible.

Touch the **NEW** button.

**Name-** A pop up keyboard will appear. Enter the name of the new Session (15 characters or less is ideal)

**Description-** Enter a description for the Schedule

**Play Duration-** This number is the estimated time it takes to complete the entire Schedule. The time value entered must be a whole number, no decimals, and equal to or less than the **Package Expiration** number entered in the above setup procedure for **ORGANIZATION, E-MAX SETTINGS**. As an example, if the Schedule runs 3 hours, enter 3 hours for **Play Duration** and 4 hours or more for **Package Expiration**. The purpose of this setup is to help prevent low battery shutdown of the E-max unit during gaming. When the purchased package is loaded into the E-max unit, the **Play Duration** is given to the E-max. The E-max unit calculates how much battery charge is present, and if the charge is not adequate to run for the duration of the Schedule, then the E-max will give an error message and refuse to load the package for play.

**Sessions-** A list of all the Sessions you have built appears on the left side of the screen. Touch the desired session in order of the way you want them played (Early Bird first), then hit the Right Arrow to include it in the Schedule. Repeat placing all desired Sessions in the right side list.

**Hit the SAVE button.**

You have now completed a Schedule.

If you wish to have multiple Schedules for different groups or special Schedules for different times of the year, you must go back and create the additional Schedules **BEFORE** proceeding to the following **Package** setup procedure.

## 6.8 Package

**PACKAGE** tab: (Combine multiple Categories, assign a specific name, and attach to a Schedule)

Packages are created for the purpose of loading them onto an E-max unit. You select a Category to be used and define how many faces of that Category are to be loaded in the E-max. Note that you can not specify more faces than the value defined in **Max Cards** under **ORGANIZATION, E-MAX SETTINGS**. Packages are attached to Schedules since all accounting and revenue tracking of E-max units is done at the Schedule level. Multiple Packages can be used in a Schedule. For example, you may want to offer 24, 36, and 50 face Packages at different price levels for the customer.

Touch the **PACKAGE** tab at the bottom of the screen.



Touch the **NEW** button.

**Name-** A pop up keyboard will appear. Enter the name of the new Session (15 characters or less is ideal)

**Description-** Enter a description for the Package

**Select a Schedule-** Select one of the Schedules you have built from the pull down list. This causes the Category lists to be displayed for that Schedule.

**Cards-** Now enter the number of card faces to be loaded in the E-max for each Category

**Hit the SAVE button.**

**CONGRATULATIONS !!!**

**YOU HAVE COMPLETED CONSOLE SETUP.**

**YOU MUST NOW COMPLETE THE POS OR LOAD & TRACK SETUP.**

## 7.0 Utilities

In this section you will learn how to:

- ❖ Create a back up CD of sessions and games
- ❖ Restore the system for a previous back up CD
- ❖ Install software updates and configure the system to your resident State
- ❖ Calibrate the touch screen
- ❖ Set the Date and Time
- ❖ Flashboard lamp test
- ❖ E-max gaming units Device Test
- ❖ Mass Download E-max gaming units
- ❖ Add a user to the security system
- ❖ Renew your License key
- ❖ Display, print, and save to CD gaming reports and logs

## 7.1 Backup

For the electronics version of the Console, the **Backup** function is very important since the E-max Console database and the E-max POS or E-max Load & Track database must kept in synchronization.

**WHEN MAKING A BACKUP OF THE CONSOLE, YOU MUST ALSO IMMEDIATELY MAKE A BACKUP OF THE POS OR LOAD & TRACK BEFORE ANY OTHER ACTIONS ARE PERFORMED ON THE SYSTEM.** Note that the same physical CD cannot be used to back up the Console and POS.

It is highly recommended that backup operations be performed after initial installation. Thereafter, whenever any important changes are made to Console setup or gaming, POS SKUs or item pricing, etc., make a backup CD on both the Console and POS.

The schedule must be deactivated for Backup to function.

1. You must log in as the System Administrator
2. Select **Utilities** from the Main Menu
3. Open the CDRW drive and insert CD
4. Touch the **Backup** button on the left side menu.
5. The backup operation screen will appear
6. Touch the **Backup** button in the center of the screen
7. A confirmation window will appear and ask you if you wish to continue
8. Touch **Yes**
9. The backup operation will run. **NOTE: This may take several minutes**
10. The Backup completed successfully window will appear when the backup operation is complete.
11. Touch **OK**
12. You will be returned to the backup screen
13. Remove CD from drive, label it with “Console” and the date, and store in a safe place.





## 7.2 Restore

### **WHEN RESTORING THE CONSOLE, YOU MUST ALSO RESTORE THE POS OR LOAD & TRACK TO THE EXACT SAME POINT IN TIME.**

Restoration of the system is needed after a CPU change, operating system load or other system failure that results in the game information being lost.

The schedule must be deactivated for Restore to function.

1. You must log in as the System Administrator
2. Select **Utilities** from the Main Menu
3. Open the CDRW drive and insert CD
4. Touch the **Restore** button on the left side menu.
5. The restore operation window will appear
6. Touch the **Refresh** button
7. A list of the available backup dates will appear on the screen
8. Select the file you wish to use for the restore by touching the **Filename**
9. Touch the **Restore** button
10. The restore operation will operation will run
11. When the restore is complete the **Restore Complete** window will appear
12. Touch **OK**
13. This will reboot the system
14. Remove the backup CD from the drive on boot up



## 7.3 Upgrade Software

The Upgrade Software utility is used for many types of software upgrades such as the State regulatory configuration of the system, the E-max gaming unit application program, and special perms. The following general procedure should be used. The schedule must be deactivated for Upgrade Software to function.

1. You must log in as the System Administrator or Technician
2. Select **Utilities** from the Main Menu
3. Open the CDRW drive and insert CD
4. Touch the **Upgrade Software** button
5. The upgrade software operation window will appear
6. Touch the **Refresh** button
7. A list of the available software updates will appear on the screen
8. Select the file you wish to install by touching the **Filename**
9. Touch the **Install** button
10. The install window will appear
11. Touch **Yes**
12. The setup wizard window will appear after a few seconds.
13. Touch **Next**
14. The configuration options window will appear
15. Select the options you wish to install by touching the check boxes
16. Touch **Next**
17. Touch **Finish** when the set up wizard window appears
18. When the configuration is complete, the computer will automatically reboot
19. While the computer is booting, remove the CD from the drive
20. The system will reboot to the Log in screen

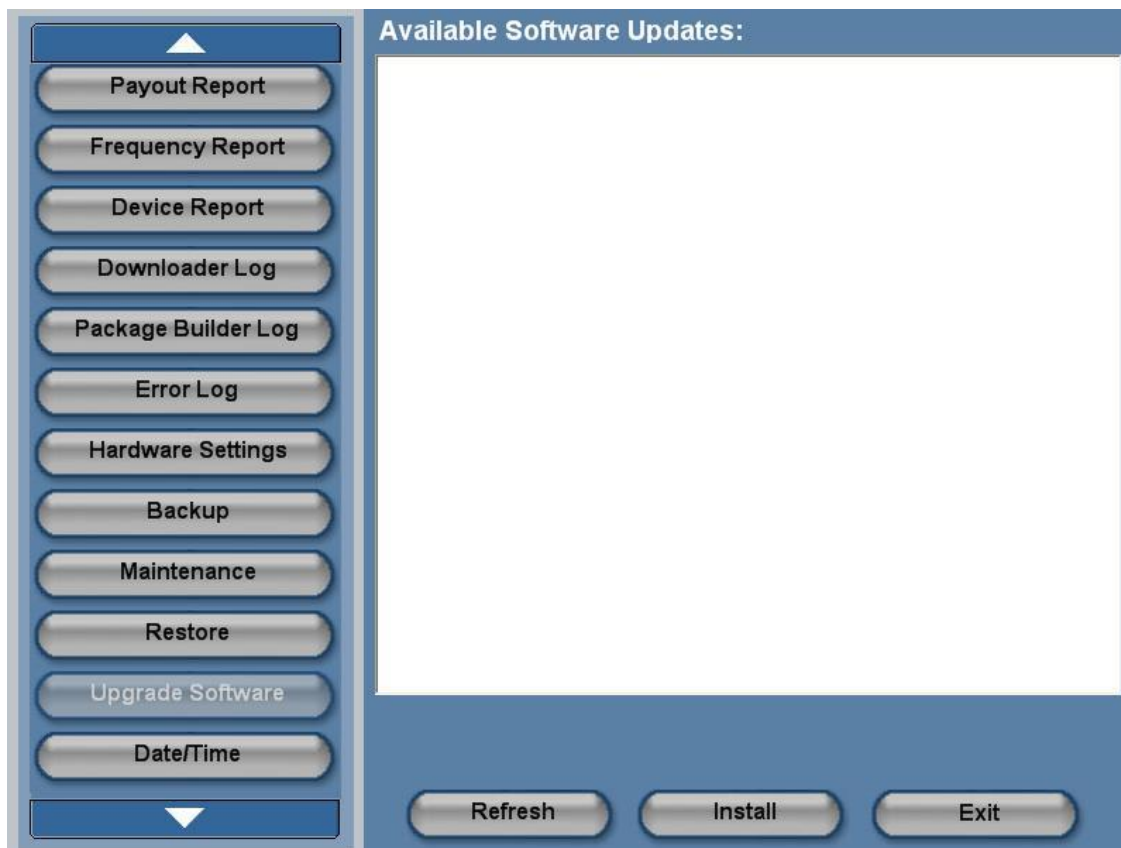

### State Regulatory Configuration CD:

Each State has different rules that determine how the Console and E-max gaming units are to perform. Typically these include restrictions on such items as the use of RNG, maximum number of cards that can be loaded into a gaming unit, playing in Auto or Manual daubing modes, etc.

Load the E-max State Configuration CD by using the general Upgrade Software procedure shown above. Specifics of this State Configuration CD are:

1. Select the resident State that the Console is to be installed in
2. Check the **E-max Electronics** box on for electronic E-max gaming operation.

#### **E-max Gaming Unit Application:**

Specifics of this upgrade are:

1. If multiple software revision levels are on the CD, select the latest revision level that is approved in your State.
2. This software will be loaded into the Console as the default application program for use by the E-max Download utility. E-max Download will force this revision level onto all gaming units in the hall.

## 7.4 Touch Screen Calibration

1. Log in as the System Administrator, Manager, Operator, or Technician
2. Select **Utilities** from the Main Menu
3. Touch the **Calibration** button
4. The calibration screen will appear
5. Touch the **Calibration** button in the center of the screen
6. The calibration screen will run through 9 points on the screen
7. Touch each calibration point as it appears on the screen
8. When all the points are finished you will be returned to the **Utilities** screen

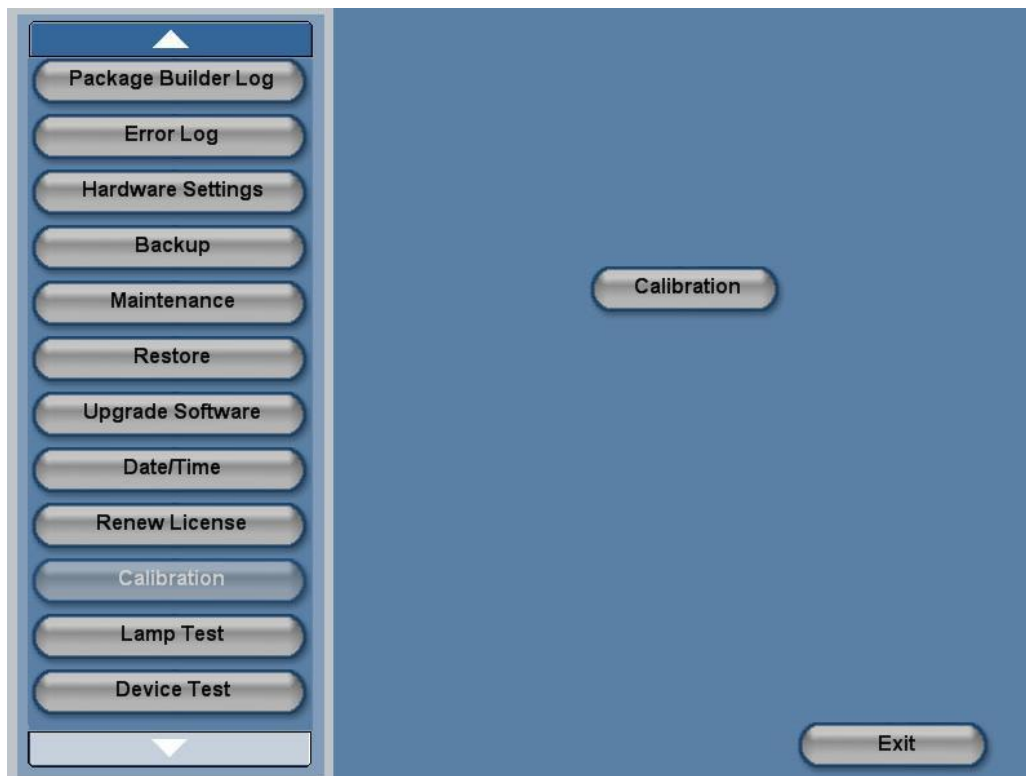

## 7.5 Set the Date and Time

1. You must log in as the System Administrator

2. Select **Utilities** from the Main Menu
3. Touch the **Date/Time** button
4. The Date/Time settings screen will appear
5. Touch the **Date** drop down menu to adjust the date
6. Touch the **Time** (arrow up/Down) to adjust the time
7. Touch the **Time Zone** drop down menu the set the time zone
8. Select the check box to allow for daylight savings time

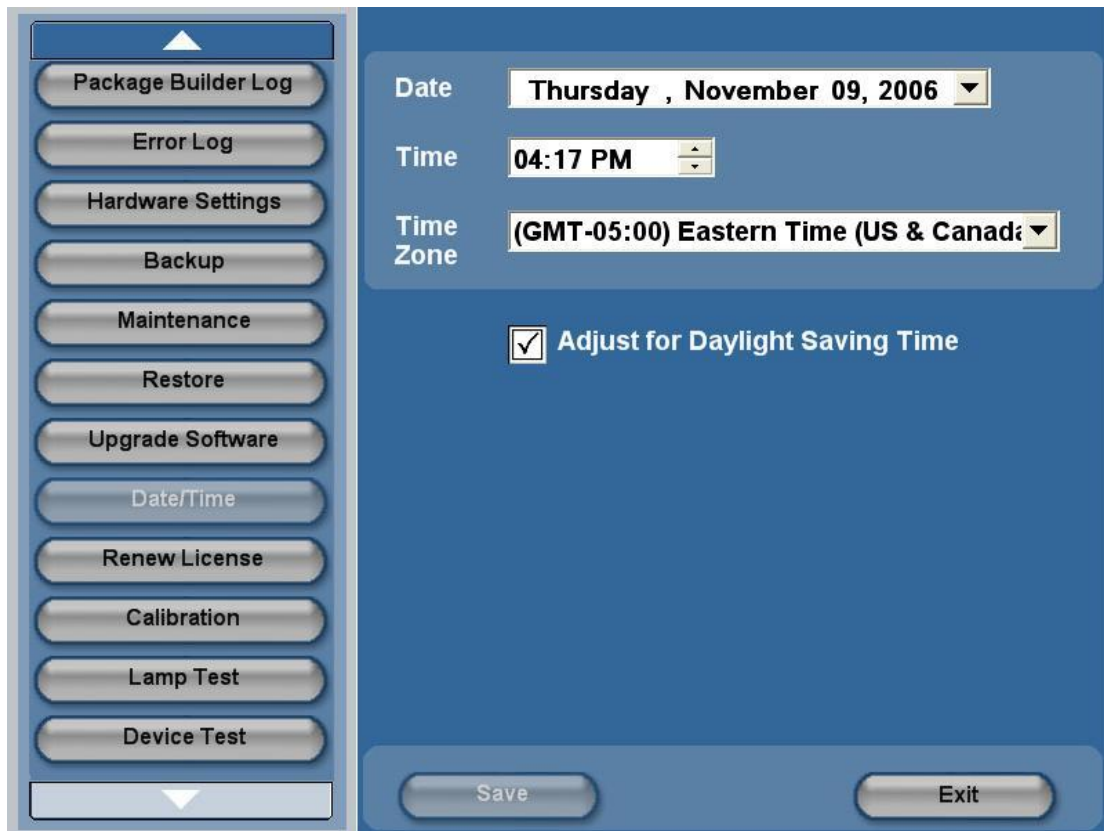

## 7.6 Test Flashboards

This test does function with an active schedule.

1. Log in as the System Administrator, Manager, Operator, or Technician

2. Select **Utilities** from the Main Menu
3. Touch the **Lamp Test** button
4. The lamp test screen will appear
5. Touch the **Test** button. (all flashboard lamps should turn on)
6. Touch the **Reset** button to turn the test off



## 7.7 E-max Gaming Unit Device Test

The following Device Test utility will test the RF network and the capability of each electronic E-max gaming unit to register itself to the Console via RF. It also provides the means to take inventory of each E-max gaming unit in the hall, locate a single unit in the hall, clear out all historical gaming logs on all E-max units in the hall, and reset the Access Points.

### **Test RF communications with each unit and take inventory:**

Note: The following test runs quickly if each E-max unit is AC line powered or is battery powered and placed in the upright, normal, playing position. If the E-max unit is in a charger, it must be blinking green and you must wait up to 10 minutes for it to respond to the test. If the charger module is turned off, or the E-max unit is blinking red, it will not respond to this test. This test is disabled during gaming.

1. Log in as the System Administrator, Manager, Operator, Technician, or Regulatory
  2. Select **Utilities** from the Main Menu
  3. Touch the **Device Test** button
  4. Touch the **Find Units** button
  5. Each E-max unit will start blinking yellow as it responds to the test and will go to a solid yellow state when it has properly registered to the Console
  6. The **Total** value shows the number of units that registered
  7. Hit **Reset** to return all E-max gaming units to their normal log in screen state with the light off
- OR**
8. To take inventory of all units with a solid yellow light, select either **Printer** or **CD** to direct the output and then press the **Inventory** button.
  9. The system will output the Device ID and all associated information such as IP address, battery data, and software revision levels

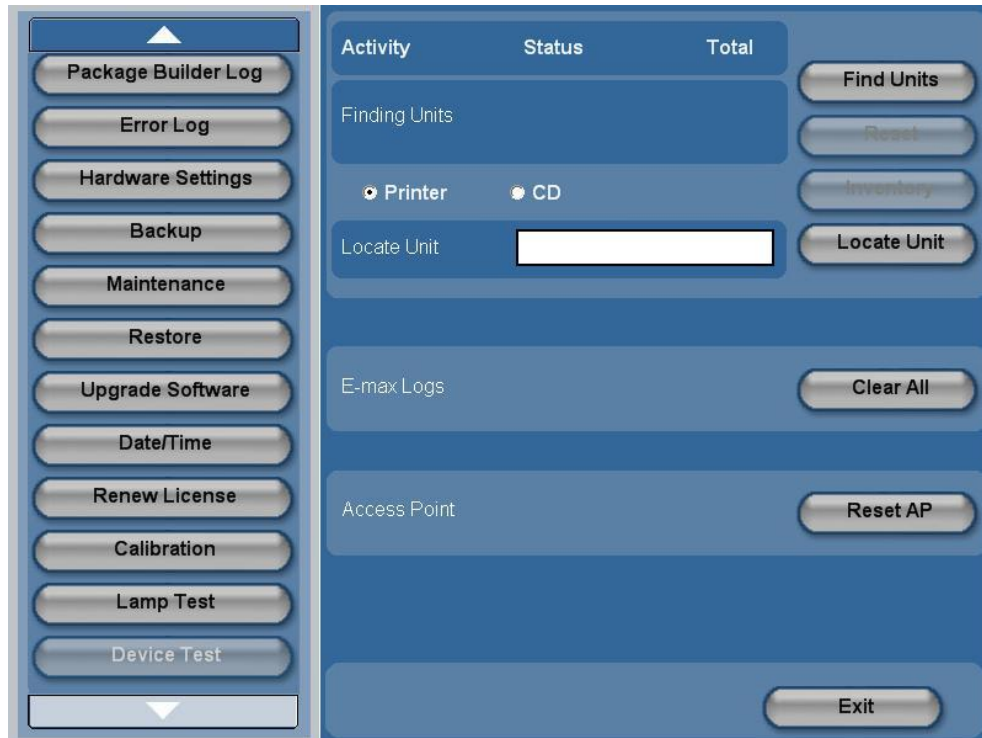

#### Locate a single E-max unit in the hall:

Note: The following test runs quickly if each E-max unit is AC line powered or is battery powered and placed in the upright, normal, playing position. If the E-max unit is in a charger, it must be blinking green and you must wait up to 10 minutes for it to respond to the test. If the charger module is turned off, or the E-max unit is blinking red, it will not respond to this test.

This test will work with an active schedule.

1. Touch the **Locate Unit** box and type in the E-max Device ID (example: **1012D**). This ID can be obtained from previous inventory reports, bad unit documentation, Device Load reports, etc..
2. The yellow light will go solid on just that specific unit.
3. The yellow light needs to be manually reset at the unit.

#### Clear out E-max gaming logs:

Note: The following test runs quickly if each E-max unit is AC line powered or is battery powered and placed in the upright, normal, playing position. If the E-max unit is in a charger, it must be blinking green and you must wait up to 10 minutes for it to respond to the test. If the charger module is turned off, or the E-max unit is blinking red, it will not respond to this test.

This test is disabled during gaming.

Each E-max unit stores historical gaming data. You may want to clear out its log file to run a specific test by touching the **Clear All** button.

**Reset the RF Access Points:**

This test is disabled during gaming.

Press **Reset AP** button to reset all Access Points attached to the system. It will take approximately 1 minute for the APs to be fully functional.

## 7.8 E-max Download

The E-max Download utility provides a means to send data simultaneously to all gaming units in the hall. This process requires approximately 20 to 30 minutes. The process starts just like Device Test in that the E-max unit must register to the Console with a solid yellow light. Therefore, the utility runs quickly if each E-max unit is AC line powered or is battery powered and placed in the upright, normal, playing position. If the E-max unit is in a charger, it must be blinking green and you must wait up to 10 minutes for it to respond to the test. If the charger module is turned off, or the E-max unit is blinking red, it will not respond to this utility.

The following is a list of the types of items that can be mass downloaded:

E-max bingo application program

Themes. (E-max can hold a max of 4 different themes)

Daubers. (E-max can hold a max of 40 different daubers)

Birthday greeting picture (E-max can hold a max of 2 different pictures)

Anniversary greeting picture (E-max can hold a max of 2 different pictures)

Any one or all of these items can be selected for a single download. If no new themes, daubers, or celebration pictures are selected for downloading, the existing items in the E-max unit are not changed or deleted. Display of the birthday or anniversary pictures on the E-max gaming unit is only enabled by the E-max Easy ID Player Tracking system provided on the E-max POS or E-max Load & Track products.

**TO ERASE THEMES ALREADY ON THE E-MAX UNIT, LOAD ONLY THE DEFAULT DAUBER THEME AND ALL OTHER THEMES WILL BE ERASED.**



You must be logged on as the System Administrator, Manager, or Technician.  
This utility only functions with a deactivated schedule.

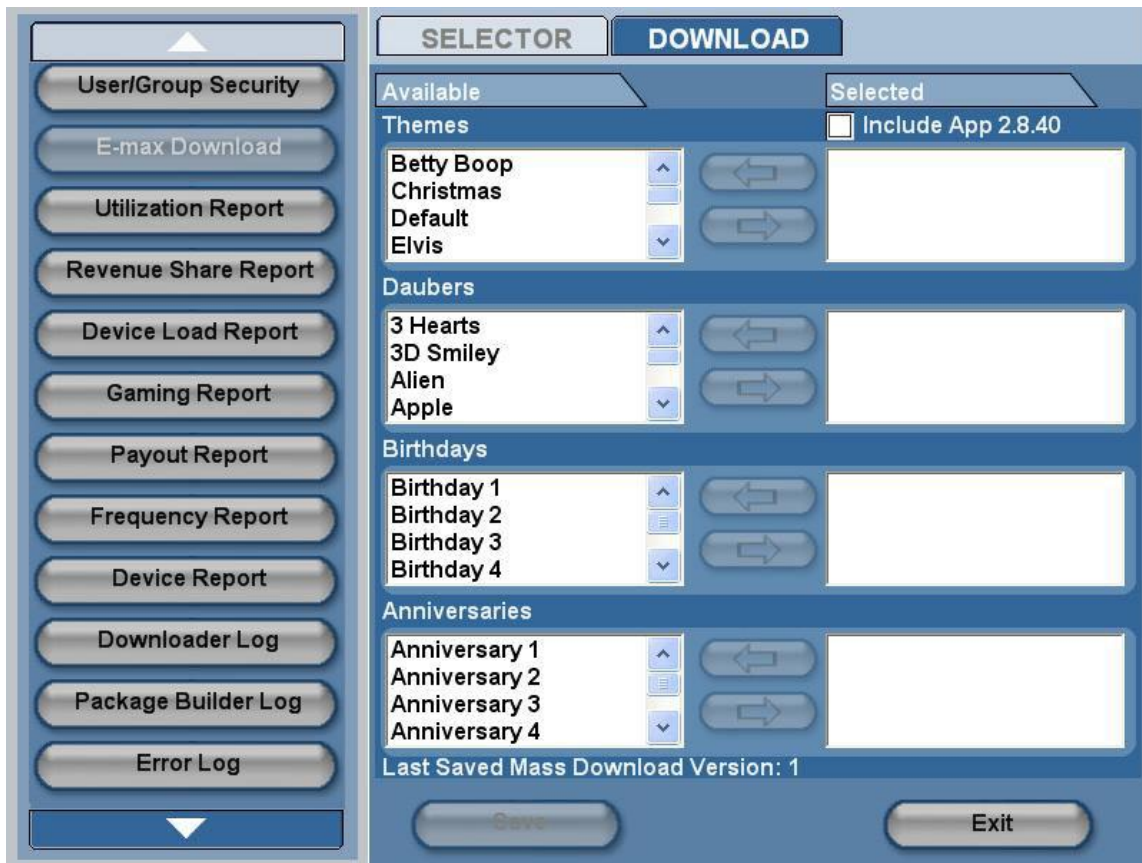

Selection of items from the **Selector** tab:

1. If the bingo application is to be downloaded, check the **Include App** box.
2. If a theme, dauber, birthday, or anniversary picture is to be downloaded, select the item in the left most box, then hit the **left to right arrow** to transfer it to the right side.
3. Hit the **Save** button. This will transfer you to the **Download** tab.



1. To start the download process, hit the Start button.
2. Each E-max unit will start blinking yellow as it responds to the download and will go to a solid yellow state when it has properly registered to the Console
3. The **Finding Units Total** will show a count of the number of solid yellow E-max units that are registered to the console.
4. If an E-max unit is not solid yellow, it may have a dead battery, or if in the charger, may be blinking red, or you may need to wait 10 minutes for it to wake up while in the charger
5. Try to remedy the lack of the solid yellow light on the problematic units.
6. When all units in the hall are a solid yellow, press the **Next** button.
7. All of the selected items will then be broadcasted to all units.
8. When the unit receives all data packets, it will turn to a solid green light.
9. The **Downloading Units** count should match the **Finding Units** count.
10. The downloader will then issue a reboot command to each individual E-max unit causing it to reboot and return to the log in screen, ready to play.
11. The **Rebooting Units** count should match the other two counts.
12. Hit the **Exit** button.
13. Typical errors that may occur will cause the E-max unit to blink or be solid red.
14. Hit the **Cancel** button to reboot all of the units and start the download process over again.

## 7.9 User Security

The User Security function is enabled during gaming, but not recommended.

Refer to **Chapter 4** to understand the logic and structure of the security system.

Log in as a System Administrator or Manager and hit the **Utilities** button on the **Main Menu** screen.

The **User/Group Security** utility displays a list of current users as shown in the large white box. Each user is assigned a **User Name**, magnetic **Card #**, and a **Password**. Each user is also assigned a **Security** classification of **Operator**, **Operator +**, **Manager**, **Technician**, or **System Administrator**.

Also displayed, is a list of Organizations that are **Available** to choose from and a list of **Selected** Organizations that an individual user has been assigned to. Selecting one of the displayed users will show all data associated with that user. Note that **Passwords** are not used for **Operator** or **Operator +**.

Log in as a System Administrator or Manager.

### To enter a new user:

1. Hit **Add New User** button
2. A pop up keyboard will appear. Enter the name of the user.
3. Touch the **Card #** white box.
4. A pop up numeric keypad appears.
5. Swipe a new magnetic card to assign the card number.
6. You will be prompted to swipe the card again, then hit **OK** button.
7. In the area labeled **Security**, select the classification of the user.
8. If not an Operator or Operator +, touch the **Password** box.
9. A pop up numeric keypad appears.
10. Enter in a password. It must be 4 digits minimum and 10 digits maximum
11. You will be prompted to enter the password again, then hit **OK** button.
12. In the **Organization Available** box, select the Organization that the user is allowed to service.
13. Hit the **Left to Right Arrow** button to place it in the **Selected** box to the right.
14. Hit **Save** button.
15. The new user will now be displayed in the list of current users.

### To edit a current user:

1. Select one of the current user from the list
2. Hit the **Edit User** button
3. Edit any information desired.
4. To remove a user from a **Selected** Organization, touch the organization in the right box, then hit the **Right to Left Arrow** button to move the organization back to the **Available** list.
5. Hit **Save** button

### To delete a user:

1. Select one of the current user from the list
2. Hit the **Delete User** button
3. You will be asked to confirm, Hit **OK** button.

▲

User/Group Security

E-max Download

Utilization Report

Revenue Share Report

Device Load Report

Gaming Report

Payout Report

Frequency Report

Device Report

Downloader Log

Package Builder Log

Error Log

▼

Demo-Manager  
Demo-Operator+  
Demo-Operator1  
**Demo-Operator2**  
Demo-Technician  
System

User Name:

Card #:

Password:

Security

- Console Operator
- Console Operator Plus
- Console Manager
- Technician
- System Administrator

Organizations

Available		Selected
Demo - Autotrst Demo - Manual Demo - Paper	← →	Demo - Auto Demo - Semi-Auto

Add New User    Edit User    Delete User

Save    Cancel    Exit

# 7.10 Renew License

Since the use of E-max electronic gaming units is a revenue-based function, the Console has a **Renew License key utility that MUST be used periodically to allow the continued use the gaming units. DO NOT LET YOUR KEY EXPIRE.**

The Renew License function is disabled during gaming.

Refer to **Chapter 4** to understand the logic and structure of the license key system.

Log in as a System Administrator and hit the **Utilities** button on the **Main Menu** screen.

### To renew the key via phone line:

1. Hit the **Renew License** button
2. Hit the **Renew - Call Now** button
3. The Console will display a confirming message that your key is renewed and the **Total Days of License Key** number will indicate how many days the key is good for.
4. Thereafter, the **Days Until Expiration** number will decrement every day and indicate how close you are to disabling of the gaming units.

### Manual key entry:

1. You will need the numbers shown in the **Key Maker** box in order for your distributor to get you a new key. Alternatively, you can hit the **Renew- Make CD** button to place the information on a CD.
2. Enter the new key number in the **License Key** box and hit the **Accept** button

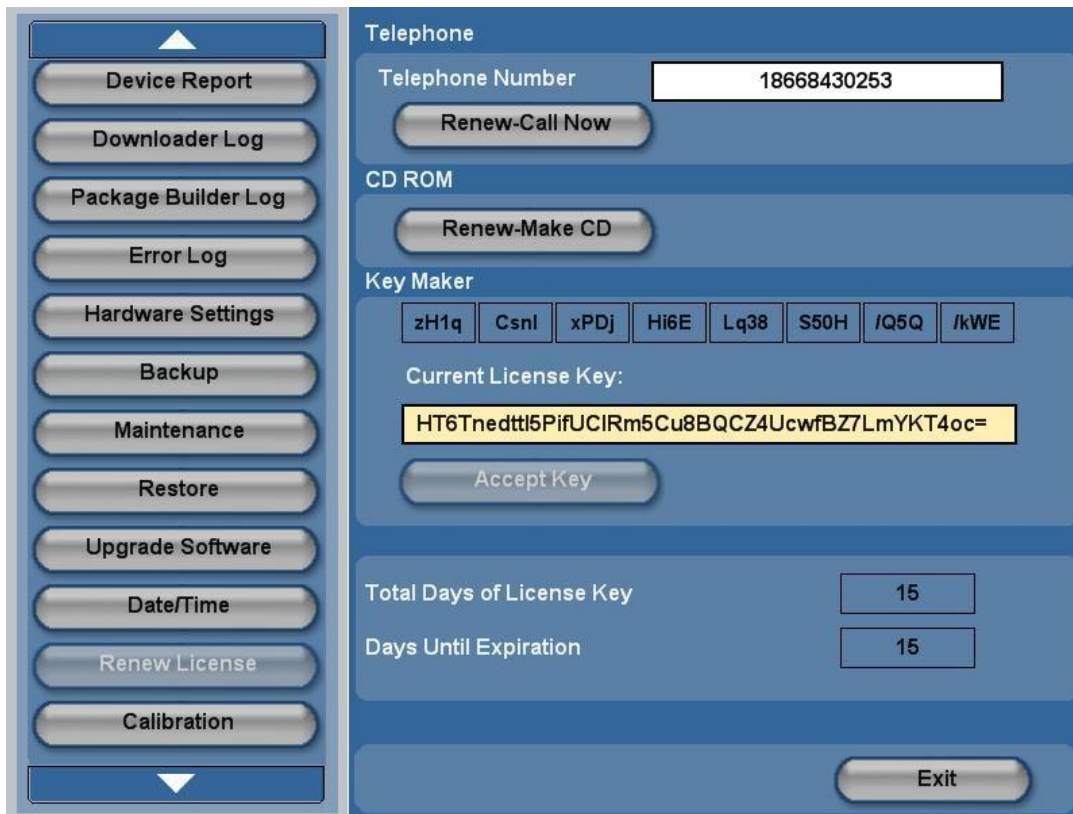

## 7.11 Reports

The Console provides many reports to document the schedule played. They are described in **Chapter 5.6**. They all use common controls to view them, print them, or record them to CD. Some reports, such as Gaming, are available during an active schedule, but most other reports are not.

1. Log in as the System Administrator, Manager, Technician, or Regulatory
2. Select **Utilities** from the Main Menu
3. Touch the desired **Report** button
4. Touch the **Schedule** drop down menu and select the schedule name
5. Touch the **Date** drop down menu to select the date of the schedule
6. The report will be display.
7. Use the **Next** and **Previous** page buttons to view a multi-page report.
8. Touch the **Print** button. (This will print out the report)
9. If you want to put the report on CD, open the CDRW drive and insert CD
10. Touch the **Write to Disk** button.

The **Transfer** button is grayed out and is for future use.

### Utilization Report:

Schedule: Demo - Auto: Demo-Schedule1  
Date: 11/16/2006 9:24:52 AM

**Device Utilization Report** Print Date: 11/16/2006

Total Voided: 0  
Total Played: 18

**Demo - Auto**

Schedule: Demo-Schedule1		11/16/06 9:24 am		
Device ID	E-Face ID	Player Tracking ID	#Faces	Download Time
00000010115	914647	0000000420	125	11/16/06 9:28 am
0000001011A	619626	0000000420	125	11/16/06 9:28 am
0000001013C	833949	0000000420	125	11/16/06 9:28 am
00000010142	716158	0000000420	125	11/16/06 9:30 am
00000010156	654351	0000000420	125	11/16/06 9:29 am
0000001015A	245454	0000000420	125	11/16/06 9:28 am
0000001015E	758635	0000000420	125	11/16/06 9:28 am
00000010164	712757	0000000420	125	11/16/06 9:29 am
0000001016F	203639	0000000420	125	11/16/06 9:28 am
00000010183	305408	0000000420	125	11/16/06 9:28 am
00000010187	435760	0000000420	125	11/16/06 9:28 am
00000010191	298022	0000000420	125	11/16/06 9:29 am
0000001019C	357696	0000000420	125	11/16/06 9:29 am
000000101AB	272826	0000000420	125	11/16/06 9:28 am
000000101BC	459459	0000000420	125	11/16/06 9:28 am
000000101C2	923419	0000000420	125	11/16/06 9:29 am
000000101D1	964441	0000000420	125	11/16/06 9:29 am
00000010205	775601	0000000420	125	11/16/06 9:28 am

Current Page No: 1 | Total Page No: 1 | Zoom Factor: Page Width

Previous Page | Next Page | Transfer (grayed out)  
Print | Write To Disk | Exit

### Revenue Share Report:

Schedule: Demo - Auto:Demo-Schedule1  
 Date: 11/16/2006 9:24:52 AM

**Revenue Share Report** Print Date: 11/16/2006

**Demo - Auto**

Item	SKU	Quantity	Item Count
Arrow RS0002	RS0002	18	2,250

Current Page No: 1 | Total Page No: 1 | Zoom Factor: Page Width

Device Load Report:

Schedule: Demo - Auto:Demo-Schedule1

Date: 11/16/2006 9:24:52 AM

Print Date: 11/16/2006

---

**Device Load Report**

Total Voided: 0

Total Reloaded: 0

Total Played: 18

---

Demo - Auto

Schedule: Demo-Schedule1

11/16/06 9:24 am

Receipt #	E-Face ID	Device ID	Player Card	Sold Time	Load Time	Reference #
20061116-2	435760	00000010187	0000000420	9:27 am	9:28 am	
20061116-3	245454	0000001015A	0000000420	9:27 am	9:28 am	
20061116-4	272826	000000101AB	0000000420	9:27 am	9:28 am	
20061116-5	833949	0000001013C	0000000420	9:27 am	9:28 am	
20061116-6	305408	00000010183	0000000420	9:27 am	9:28 am	
20061116-8	758635	0000001015E	0000000420	9:27 am	9:28 am	
20061116-9	203639	0000001016F	0000000420	9:27 am	9:28 am	
20061116-10	914647	00000010115	0000000420	9:27 am	9:28 am	
20061116-11	775601	00000010205	0000000420	9:27 am	9:28 am	
20061116-12	619626	0000001011A	0000000420	9:27 am	9:28 am	
20061116-13	459459	000000101BC	0000000420	9:27 am	9:28 am	
20061116-14	923419	000000101C2	0000000420	9:27 am	9:29 am	
20061116-15	654351	00000010156	0000000420	9:28 am	9:29 am	
20061116-16	964441	000000101D1	0000000420	9:28 am	9:29 am	
20061116-17	712757	00000010164	0000000420	9:28 am	9:29 am	
20061116-18	298022	00000010191	0000000420	9:28 am	9:29 am	
20061116-19	357696	0000001019C	0000000420	9:28 am	9:29 am	
20061116-21	716158	00000010142	0000000420	9:28 am	9:30 am	

Current Page No: 1
Total Page No: 1
Zoom Factor: Page Width

Previous Page

Print

Next Page

Write To Disk

Transfer

Exit



Gaming Report:

▲

User/Group Security

E-max Download

Utilization Report

Revenue Share Report

Device Load Report

Gaming Report

Payout Report

Frequency Report

Device Report

Downloader Log

Package Builder Log

Error Log

▼

Schedule: Demo - Auto:Demo-Schedule1

Date: 11/16/2006 9:24:52 AM

Print Date: 11/16/06

Gaming Report

Demo - Auto

Schedule: Demo-Schedule1 11/16/2006 9:24:52AM

Operator:		System	
Session: Demo-Session			
Game:	Regular 1	Group #1 Name (String)	
( 1 ) Part:	1 / 1		
1	Ball#: 22	Call	9:31:45 am
2	Ball#: 37	Call	9:31:46 am
3	Ball#: 53	Call	9:31:46 am
4	Ball#: 38	Call	9:31:47 am
5	Ball#: 39	Call	9:31:47 am
6	Ball#: 24	Call	9:31:47 am
7	Ball#: 23	Call	9:31:48 am
8	Ball#: 36	Call	9:31:48 am
9	Ball#: 51	Call	9:31:49 am
10	Ball#: 66	Call	9:31:49 am
11	Ball#: 8	Call	9:32:19 am
12	Ball#: 75	Call	9:32:20 am
13	Ball#: 12	Call	9:32:24 am
14	Ball#: 27	Call	9:32:25 am
15	Ball#: 68	Call	9:32:30 am
16	Ball#: 57	Call	9:32:31 am
Demo-Electronic	E-max	Free Space: 50	9:32:40 am

\$75.00	6	21	42	63	84
	1	20	41	62	83
	5	16	37	46	66
	13	27	39	51	72
	12	28	38	58	73

<b>Part Total:</b>	<b>\$75.00</b>
<b>Game Total:</b>	<b>\$75.00</b>

Current Page No: 1	Total Page No: 5	Zoom Factor: Page Width
--------------------	------------------	-------------------------

Previous Page	Next Page	Delete
Print	Write To Disk	Exit

**Payout Report:**

▲

User/Group Security

E-max Download

Utilization Report

Revenue Share Report

Device Load Report

Gaming Report

Payout Report

Frequency Report

Device Report

Downloader Log

Package Builder Log

Error Log

▼

Schedule: **Demo - Auto:Demo-Schedule1** ▼

Date: **11/16/2006 9:24:52 AM** ▼

Payout Report

Print Date: 11/16/2006

---

Demo - Auto

Schedule: Demo-Schedule1 11/16/06 9:24 am

Session: Demo-Session

Game: Regular 1

( 1 )Part: 1 / 1

Category	Series	Card#	Payout Date	Face																									
Demo-Electronic	E-max 1-100,000	50	\$75.00 11/16/06 9:32 am	<table style="font-size: 0.7em; border-collapse: collapse;"> <tr><td>2</td><td>25</td><td>42</td><td>53</td><td>59</td></tr> <tr><td>1</td><td>33</td><td>44</td><td>57</td><td>61</td></tr> <tr><td>5</td><td>10</td><td>9</td><td>43</td><td>56</td></tr> <tr><td>13</td><td>30</td><td>37</td><td>51</td><td>72</td></tr> <tr><td>14</td><td>28</td><td>35</td><td>55</td><td>73</td></tr> </table>	2	25	42	53	59	1	33	44	57	61	5	10	9	43	56	13	30	37	51	72	14	28	35	55	73
2	25	42	53	59																									
1	33	44	57	61																									
5	10	9	43	56																									
13	30	37	51	72																									
14	28	35	55	73																									
<b>Part Total:</b>			<b>\$75.00</b>																										
<b>Game Total:</b>			<b>\$75.00</b>																										

Game: Regular 2

( 2 )Part: 1 / 1

PayoutSpecial\_Face.Game (String)

Category	Series	Card#	Payout Date	Face																									
Demo-Electronic	E-max 1-100,000	37	\$99.00 11/16/06 9:33 am	<table style="font-size: 0.7em; border-collapse: collapse;"> <tr><td>4</td><td>21</td><td>42</td><td>40</td><td>86</td></tr> <tr><td>6</td><td>34</td><td>41</td><td>65</td><td>89</td></tr> <tr><td>8</td><td>10</td><td>0</td><td>21</td><td>81</td></tr> <tr><td>16</td><td>33</td><td>32</td><td>64</td><td>84</td></tr> <tr><td>1</td><td>19</td><td>39</td><td>46</td><td>78</td></tr> </table>	4	21	42	40	86	6	34	41	65	89	8	10	0	21	81	16	33	32	64	84	1	19	39	46	78
4	21	42	40	86																									
6	34	41	65	89																									
8	10	0	21	81																									
16	33	32	64	84																									
1	19	39	46	78																									
<b>Part Total:</b>			<b>\$99.00</b>																										
<b>Game Total:</b>			<b>\$99.00</b>																										

Game: Regular 3

Current Page No: 1    Total Page No: 2    Zoom Factor: Page Width

Previous Page

Next Page

Transfer

Print

Write To Disk

Exit

Frequency Report:

Schedule: Demo - Auto:Demo-Schedule1  
Date: 11/16/2006 9:24:52 AM

**Ball Frequency Report** Print Date: 11/16/2006

Demo - Auto  
Schedule: Demo-Schedule1 11/16/06 9:24 am

Ball #	Count
1	2
2	2
3	2
4	2
5	2
6	2
7	2
8	2
9	2
10	2
11	2
12	2
13	0
14	2
15	2
16	2
17	2
18	2
19	2
20	2
21	2
22	2
23	2
24	3
25	0
26	2
27	2
28	2
29	2
30	2
31	2
32	2
33	2
34	2
35	2
36	2
37	2
38	2
39	2
40	2
41	2
42	2
43	2
44	2
45	2
46	2
47	2
48	2
49	2
50	2

Current Page No: 1 | Total Page No: 1 | Zoom Factor: Page Width

Delete Transfer  
Print Write To Disk Exit

## Device Report:

The screenshot shows a software interface for generating reports. On the left is a vertical sidebar with buttons for: User/Group Security, E-max Download, Utilization Report, Revenue Share Report, Device Load Report, Gaming Report, Payout Report, Frequency Report, Device Report, Downloader Log, Package Builder Log, and Error Log. The main window displays a 'Device Report' for 'Demo - Auto' on '11/16/2006 9:24:52 AM'. The report includes a table with columns for Device ID, IP Address, MAC Address, and Battery Pack ID. Below the table, it states 'Total Reported Device: 9'. At the bottom of the main window, there are controls for 'Current Page No: 1', 'Total Page No: 1', and 'Zoom Factor: Page Width'. A bottom navigation bar contains buttons for 'Previous Page', 'Next Page', 'Transfer', 'Print', 'Write To Disk', and 'Exit'.

Schedule: Demo - Auto:Demo-Schedule1  
Date: 11/16/2006 9:24:52 AM

**Device Report** Print Date: 11/16/2006  
Demo - Auto  
Schedule: Demo-Schedule1 11/16/06 9:24 am

Device ID	IP Address	MAC Address	Battery Pack ID
00000010115	10.1.1.21	00:0F:F8:4E:0E:9B	FFFFFFFFFFFF
0000001012C	10.1.1.44	00:0F:F8:4E:11:B8	FFFFFFFFFFFF
0000001013C	10.1.1.60	00:0F:F8:4E:0C:E3	FFFFFFFFFFFF
00000010142	10.1.1.66	00:0F:F8:4E:13:83	FFFFFFFFFFFF
00000010156	10.1.1.86	00:0F:F8:4E:0D:74	FFFFFFFFFFFF
00000010180	10.1.1.128	00:0F:F8:4E:0E:8B	FFFFFFFFFFFF
00000010183	10.1.1.131	00:0F:F8:4E:0A:F4	FFFFFFFFFFFF
0000001018C	10.1.1.188	00:0F:F8:4E:0C:59	FFFFFFFFFFFF
000000101D1	10.1.1.209	00:0F:F8:4E:13:7B	FFFFFFFFFFFF

Total Reported Device: 9

Current Page No: 1 Total Page No: 1 Zoom Factor: Page Width

Previous Page Next Page Transfer  
Print Write To Disk Exit

## Inventory Report:

This report is generated with the Device Test Utility function (Not shown)

The report documents date/time, Console ID, and total number of E-max devices that reported during the forced inventory.

Also, for each E-max gaming unit reported during the forced inventory, the report contains:

Device ID

Device IP Address

Radio Mac Address

Battery Pack ID

O.S. software version

Application software version

PIC internal microcontroller software version

Radio internal software version

## 7.12 System Logs

The Console generates several system log files to be used for troubleshooting.

**Package Builder Log**- Traces the POS and Load & Track requests for building of sold electronic packages

**Download Log**- Traces the requests from the E-max gaming unit to load the package into a specific device

**Error Log** - Traces general system errors

1. Log in as the System Administrator or Technician
2. Select **Utilities** from the Main Menu
3. Touch the desired **Log** button
4. Touch the **Schedule** drop down menu and select the schedule name
5. Touch the **Date** drop down menu to select the date of the schedule
6. The report will be display.
7. Use the scroll bars on the right side of the screen to view the logs
8. Touch the **Print** button. (This will print out the logs)
9. If you want to put the report on CD, open the CDRW drive and insert CD
10. Touch the **Write to Disk** button.
11. Touch the **Refresh** button to update the screen with the latest data.
12. Touch the **Delete** button to clear the log file.

The screenshot displays the 'System Logs' application interface. On the left is a vertical sidebar with buttons for various reports: User/Group Security, Utilization Report, Revenue Share Report, Device Load Report, Gaming Report, Payout Report, Frequency Report, Device Report, Downloader Log, Package Builder Log, Error Log, and Hardware Settings. The main area shows a log for 'Schedule: Demo - Auto:Demo-Schedule1' with a date of '11/16/2006 2:54:04 PM'. The log text includes timestamps and details of download requests and network transfers. At the bottom, there are five buttons: Refresh, Delete, Print, Write To Disk, and Exit.

```
11/16/2006 15:08:12 | Download Request: 10.1.1.135 requesting package 0000000420
11/16/2006 15:08:13 | _packageID is: 36' | SHID:2
11/16/2006 15:08:13 | Package was located for: PN '0000000420' | SHID:2
11/16/2006 15:08:13 | Package obtain:36 Time:375
11/16/2006 15:08:13 | Package for: PN '0000000420' Package ID: 36 is 57752 bytes long and being downloaded.
11/16/2006 15:08:13 | -- Network Transfer Begin: 10.1.1.135 Size: 10646
11/16/2006 15:08:14 | Download Request: 10.1.1.90 requesting package 0000000420
11/16/2006 15:08:14 | _packageID is: 37' | SHID:2
11/16/2006 15:08:15 | Package was located for: PN '0000000420' | SHID:2
11/16/2006 15:08:15 | Package obtain:37 Time:422
11/16/2006 15:08:15 | Package for: PN '0000000420' Package ID: 37 is 57887 bytes long and being downloaded.
11/16/2006 15:08:15 | Download Request: 10.1.1.171 requesting package 0000000420
11/16/2006 15:08:15 | -- Network Transfer Begin: 10.1.1.90 Size: 10664
```

## 7.13 File Maintenance

This utility is not available during an active schedule.

1. Log in as the System Administrator
2. Select **Utilities** from the Main Menu
3. Touch the **Maintenance** button
4. Hit the **Clear** button to clear existing data files
5. A confirmation window will appear
6. Hit **OK**
7. If you wish to change the duration that the data is stored, hit the data white box
8. A pop up keypad appears
9. Enter the new duration between 13 and 24 months
10. Hit **Save** button



## 7.14 Hardware Settings

This function can be executed with an active schedule, but not recommended.

1. Log in as the System Administrator or Technician
2. Select **Utilities** from the Main Menu
3. Touch the **Hardware Settings** button
4. The **Single Blower** setting is on to match the Express Console hardware
5. The Console can send reports to a network printer (6940).
6. Select the printer output device.
7. Touch **Print Test Page** button.
8. Touch the **Save** button
9. Note that other devices in the Console system have software revision numbers displayed.



# 8.0 Special Functions

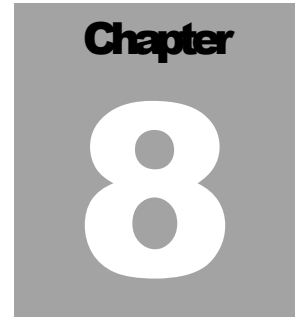

## 8.1 Wild Number

The following wild number options are available to select from:

- **EVEN** – All even numbers will be called.
- **ODD** – All odd numbers will be called.
- **Trailing Number** – Any number ending with that number will be called.
- **Leading Number** – Any number beginning with that number will be called.
- **Day-** All odd or all even numbers will be called based on the calendar date.
- **Double Reverse-** Calls the reverse of the last number called.
- **Even/Odd Ball-** Calls Odd or Even balls based on the first ball called

1. Touch the **SETUP** button from the **Main Menu**.
2. Touch the desired Organization from the **Organization** Screen.
3. Touch the **Sessions** tab.
4. Touch your desired **Session** from the list of available sessions.
5. Touch the **EDIT** button.
6. Touch the **Wild Number** drop down list box from the **Part** area.
7. Select the desired Wild Number option and touch the **ADD** button. This will place the selected Wild Number in the Wild Number list box.

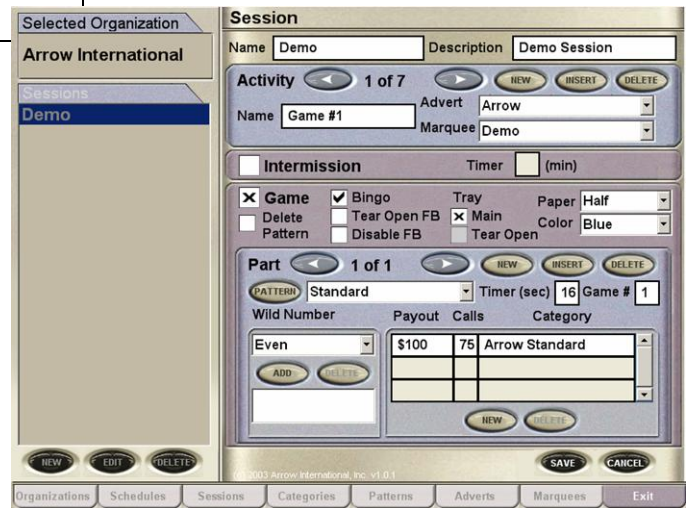



## 9.0 Servicing and Cleaning

Chapter

9

### 9.1 General Cleaning

Periodic servicing of your bingo equipment should include cleaning, polishing, and light bulb replacement. Doing so will prolong the life of the equipment, increase trade in value, and reduce breakdowns. Recommended cleaning agents and methods for the console and flashboard are as follows:

#### **Monitor Touch Screen**

Pour rubbing alcohol on a clean soft cloth and gently rub the screen to remove greasy finger prints. CAUTION: Do not pour alcohol, water or any other liquid directly on the screen.

#### **Console Painted Metal Surface**

Use a mild soap solution or mild cleanser on a soft cloth. Harsh cleansers or solvents may damage the paint or lettering. Follow with an automotive style polish for additional protection. CAUTION: Do not pour alcohol, water or any other liquid directly on the surface.

#### **Console Laminate Panels**

Use a mild soap solution or Kitchen style cleaner on a soft cloth. Harsh cleaners or solvents may damage the laminate surface.

#### **Console and Flashboard Acrylic Surfaces**

Use only a mild soap solution such as a liquid detergent solution on a clean soft cloth. Do not use solvents, aromatic spirits, mild cleansers or paper towels since they may scratch the surface. CAUTION: Do not pour alcohol, water or any other liquid directly on the surface.

#### **Camera Lens**

Use a vacuum cleaner to remove major dust and debris. Use a soft cloth to wipe lens.

#### **Bingo Balls**

Clean with a soft cloth and mild soap solution such as a liquid detergent and warm water (not hot water) or a solution of 25% rubbing alcohol and 75% warm water. Harsh cleansers or solvents may damage the finish or lettering. Dry the balls thoroughly using a cloth towel. Do not submerge the balls in liquids or use automatic washing machines.

## 9.2 Replacing the Blower Air Filter

**CAUTION!** Insure that the ball console power switch for the blower motor is in the off position before servicing the filter.

The air filter is located in the Console behind the access panel (**Figure 8.0**) Unscrew the two turn button screws on each side of the access panel to remove the access panel. Slide each air filter locking retainer away from the filter then pull filter up to remove. Air filter should be replaced with the filter specified in Appendix B. Air filter replacement interval varies depending on hall air conditions and number of hours played. Check filter once a month. A dirty filter can cause motor overheating and poor ball action.



Figure 8.0

## 9.3 Replacing the Arm Rest

Call for Service to replace Arm Rest.

## 9.4 Cleaning Ball Tray Chamber

Call your authorized E-max™ distributor for all ball chamber maintenance

**FOR ALL OTHER SERVICE NEEDS CONTACT YOUR LOCAL DISTRIBUTOR OR E-max™ REPRESENTATIVE.**

# 10.0 Troubleshooting and Diagnostics



## **HAZARD!**

Note that when trouble shooting electrical systems, be aware of the potential dangers of coming in contact with 120VAC line voltages. Use caution when handling AC power cords and devices. When feasible, during the trouble shooting procedure, turn off the AC power input when handling these devices if you are concerned with safety or call your service personnel for assistance.

When working with fuses or circuit breakers, call for service.

The trouble shooting guide is broken down into two main sections:

1. Power Issues
2. Electronic Issues

Isolate your particular problem to one of these sections and then refer to that section for guidance.

**System Power Issues:**

<b>Problem</b>	<b>Possible Cause</b>	<b>What to do or check</b>
Console has no power	Hall power not available	Check hall fuses or circuit breakers
	Power cord not plugged into hall power	Plug cord into 120 VAC, grounded power source
	GFI circuit breaker tripped	Press the reset button on the junction box circuit breaker
	UPS power switch not ON	Depress power ON switch
	UPS circuit breaker tripped	Depress UPS circuit breaker button on the back of the UPS
Power available, but console equipment not powered correctly	Computer AC cord unplugged from UPS	Plug in power cord to UPS1 socket as shown in the Appendix
	Computer turned off	Depress power ON button on computer
	Operator Monitor AC cord unplugged from UPS	Plug in Operator Monitor AC cord to UPS2 socket as shown in the Appendix
	Operator Monitor turned off	Depress Monitor ON switch on the front panel of the monitor
	Blower motor AC cord not plugged in	Access the filter compartment and verify AC cord is plugged into AC socket provided.
	Blower motor switch OFF	Place the switch on the ball tray to the ON position
UPS did not work properly when AC power failed	UPS defective or battery pack worn or defective	Call for service to replace the UPS
UPS is beeping	Low AC line voltage	Specification in Appendix

**Electronic Issues:**

<b>Problem</b>	<b>Possible Cause</b>	<b>What to do or check</b>
Operator Monitor touch panel not operating properly	Touch panel calibration	Calibrate the touch panel using Utilities provided
	Touch panel defective	Call for service
	Touch panel cable unplugged	Plug in cable to computer and/or Monitor as shown in Appendix
	Computer defective	Call for service
Operator Monitor video image	Monitor data cable unplugged	Plug in cable to computer and/or Monitor as shown in Appendix
	Display defective	Call for service
	Computer defective	Call for service
Operator Monitor audio	Monitor audio cable unplugged	Plug in cable to computer and/or Monitor as shown in Appendix
	Monitor speakers defective	Call for service
	Computer defective	Call for service
Magnetic card reader	Cable unplugged	Plug in cable to computer as shown in Appendix
	Defective reader	Call for service
	Computer defective	Call for service
Data Router status LEDs not on	Data Router software	Depress the Data Router Reset switch
	Computer defective	Call for service.

**Electronic Issues (continued):**

<b>Problem</b>	<b>Possible Cause</b>	<b>What to do or check</b>
Particular Data Router flashboard LED and associated flashboards not working	Individual flashboard driver fuse blown	Transfer flashboard cable to an unused connector, if available. If not available, call for service
Computer not operating properly	Program misoperating	Exit the program and do an orderly shutdown of the computer. Power the computer OFF with its power switch. Shut off the UPS with the UPS OFF switch. Power the UPS back ON. Power the computer back ON. If still not operating properly, call for service and try Manual Mode operations.
	Excessive noise on the AC power line	Provide cleaner AC power to the system
	Corrupted hard drive	Place Operating System CD Disk #1 in CD drive and restart computer. Follow instructions on screen loading all Operating System CDs then Applications CD and last the Console Backup CD of your database.
	Cooling fan not operating	Call for service
Monitor arm	Defective or broken	Call for service
Mouse or keyboard	Cable(s) unplugged	Plug in cable(s) to computer as shown in Appendix
	Defective equipment	Call for service

**Electronic Issues (continued):**

<b>Problem</b>	<b>Possible Cause</b>	<b>What to do or check</b>
Poor bingo ball action	Clogged blower air filter	Replace filter
	Low line voltage	Specification in Appendix
	Excessive static	Make sure anti-static band is installed in the bottom of the ball chamber. If it is installed, call for service
	Lid on inner ball chamber misaligned	Check for proper seating of the lid and that ball extraction tube is centered over blower hole
	Defective blower motor	Call for service
None of the ball tray switches work	Ball Tray cable unplugged from computer	Plug in cable to computer as shown in Appendix
	Data Router or Ball Tray software	Depress Reset switch on the front of the Data Router
	Defective Ball Tray	Call for service. In the meantime, use the touch panel on the Operator Monitor to call and reset balls
	Defective Data Router/Computer	Call for service
One or a few of the ball tray switches do not work	Defective Ball Tray	Call for service. In the meantime, use the touch panel on the Operator Monitor to call and reset balls
No camera image, and no camera white LEDs are on	Communications cable unplugged	Plug in Camera cable to computer USB port as shown in Appendix
	Computer not turned on	Depress ON switch
	Computer defective	Call for service
	Led board defective	Call for service

Camera does not display ball image on Operator Monitor	Program is not on the main Operator gaming screen	Use touch panel to display the main Operating gaming screen
	Camera lens is blocked by foreign material	Remove material from the camera lens area
	Ball tube not centered over camera	Rotate the ball tube until it is centered over the camera
	Camera defective	Call for service
Manual Mode switches do not operate, switch LEDs are off	When the computer is normal, the switches are disabled and LEDs are off.	System OK
Manual Mode switch(s) do not operate when Manual Mode is enabled and LEDs are on.	Defective switch(s)	Call for service.
	Defective Ball Tray	Call for service.
	Defective Data Router/Computer	Call for service.
All bingo balls do not return to mixing chamber when the red Door release knob is used	Dirty ball tray chamber	Call for service.
Ball Tray release (two black knobs) do not return to their normal position after releasing balls into the ball tray chamber	Improper ball tray return spring tension or dirt accumulation	Call for service.
Depressing the bingo ball on the ball tray switch works the first time, but not the second time	During a given game, the system disables all repeat actuations of a ball tray switch	System OK. The switch will become active again on Next Game.



**Electronic Issues (continued):**

<b>Problem</b>	<b>Possible Cause</b>	<b>What to do or check</b>
No video image on the hall Ball Monitor	Video cable not plugged into the Data Router/Computer	Check video cabling as shown in the Appendix
	Defective Data Router/Computer	Call for service.
Flashboards not operating	Flashboard cable not plugged into the Data Router/Computer	Check that cabling is plugged into the correct RJ connector on the Data Router as shown in the Appendix
	Data Router problem	Check Data Router troubleshooting procedures shown above
	Computer problem	Check computer troubleshooting procedures shown above
	Flashboard type not compatible with new Console	Call for service.
Add on Electronic gaming unit system does not work properly with new Console	Not certified by EGC as compatible	Call for service.

# 10.1 UPS Status Indicators and Alarms

There are four status indicators (lights) on the front of the UPS.

**On Line (GREEN)** – is lit whenever utility power is powering the Battery Backup outlets.

**On Battery (YELLOW)** – is lit whenever the battery of the UPS is powering equipment connected to the Battery Backup Outlets.

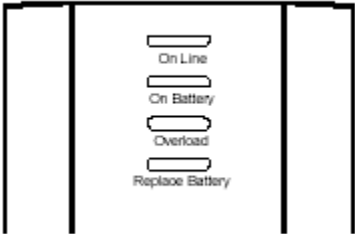

**Four Beeps Every 30 Seconds** – this alarm is sounded whenever the UPS is running on Battery. There is approximately 10 minutes of run time on batteries. Suggest waiting 1-2 minutes in case the main power is restored then start shutting the computer down in an orderly manner.



**Continuous Beeping** – this alarm is sounded whenever a low battery condition is reached. Battery run-time is very low. The computer must be entirely shut down by this time.

**Overload (RED)** – is lit whenever power demand has exceeded the capacity of the UPS.



**Continuous Tone** – this alarm is sounded whenever the Battery Backup outlets are overloaded.



**Circuit Breaker** – the circuit breaker button located on the rear panel of the UPS will stick out if an overload condition forces the UPS to disconnect itself from utility power. Reset the circuit breaker by pushing the button inward.

**Replace Battery (RED)** – is lit whenever the battery is near the end of its useful life, or if the battery is not connected. A battery that is near end of its useful life has insufficient runtime and should be replaced. **(CALL FOR SERVICE IF THIS OCCURS!)**



**Chirps for 1 Minute Every 5 Hours** – this alarm is sounded whenever the battery has failed the automatic diagnostic test.

# Warranty Information

## Chapter

# 11

## **E-max™ BINGO EQUIPMENT LIMITED WARRANTY**

Set out below are the terms of the Limited Warranty made by E-max™ Gaming Corporation, Inc. (EGC) with the sale of Equipment (the "Equipment").

### **1. Limited Warranty**

EGC warrants to the original purchaser ('Purchaser') that the Equipment will, for a period of ONE (1) YEAR from the date of original purchase of any Equipment in the 'E-max™' product line from an authorized EGC dealer, be free from manufacturing defects in material and workmanship. Purchaser represents to EGC that no employee, agent, or representative of EGC (or an EGC dealer) has made any representation or warranty regarding the Equipment except as set out herein.

This Limited Warranty applies to normal commercial use and does not cover failures or damage which (a) occurs in shipment; (b) are caused by products not supplied by EGC; or (c) result from accident, misuse, abuse, neglect, mishandling, misapplication, alteration, set-up-adjustments or modifications. This Limited Warranty also does not cover any damage resulting from failure to install the Equipment in strict conformity with both local fire and building codes and regulations, or if the installation does not comply with the installation instructions provided by EGC.

### **2. Disclaimer of Warranties**

EGC MAKES NO WARRANTIES, EXPRESS OR IMPLIED (INCLUDING, WITHOUT LIMITATION, MERCHANTABILITY, FITNESS FOR PARTICULAR PURPOSE, OR AGAINST INFRINGEMENT OF ANY PATENT), EXCEPT AS EXPRESSLY PROVIDED HEREIN. THE EXPRESS WARRANTIES PROVIDED HEREIN ARE IN LIEU OF AND EXCLUDE ALL OTHER WARRANTIES, GUARANTEES OR REPRESENTATIONS, EXPRESS OR IMPLIED, WHETHER ARISING BY OPERATION OF LAW OR OTHERWISE.

### **3. Limitation of Remedies**

If the Equipment supplied does not conform to the Limited Warranty set out above, EGC will, at its option, (a) repair or replace the Equipment, or part thereof, which is defective, or (b) refund so much of the purchase price as Purchaser has paid for the defective equipment, less 1/24th of the purchase price for each month between the date of the purchase from an authorized EGC dealer and the date of the discovery of the defect, provided that written notice of the defect and its nature is given to EGC as soon as practical after discovery of the defect, but in no event later than 90 days from the date of the discovery of the defect.

### **4. Limitation of Liability**

The remedy of repair, replacement, or refund of the purchase price is Purchaser's sole and exclusive remedy and will satisfy all of EGC's liabilities, whether based on contract, negligence, tort, product liability, strict liability or otherwise. IN NO EVENT WILL EGC BE LIABLE FOR INCIDENTAL OR CONSEQUENTIAL DAMAGES, NOR WILL ITS LIABILITY IN CONNECTION WITH ANY EQUIPMENT OR SERVICE SOLD (INCLUDING NONDELIVERY OR LATE DELIVERY THEREOF) EXCEED THE SALE PRICE OF SUCH EQUIPMENT OR SERVICE.

## **5. Warranty Voided**

**Any obligations of EGC under this Limited Warranty will be deemed to have been satisfied if anyone other than an authorized Equipment Dealer services the equipment.**

## **6. Transfer of Limited Warranty**

Purchaser may transfer its rights under this Limited Warranty, subject to the terms and conditions hereof, to a buyer ("Buyer") from Purchaser of the Equipment. Thereafter, the rights under this Limited Warranty are not transferable.

For the transfer by Purchaser of the Limited Warranty to be effective, the following conditions must have occurred no later than the 30th day following the date of resale to Buyer:

- A. Purchaser must have complied with all requirements to make the Limited Warranty effective as to Purchaser; and
- B. The Equipment (as an entire unit and as purchased by Purchaser) must be transferred to Buyer.

Upon an effective transfer of this Limited Warranty, Buyer will be considered to be 'Purchaser' for paragraphs 1, 4 and 8 hereof.

## **7. Inspection**

With respect to any claim that the Equipment is defective, EGC will be allowed a reasonable time to inspect the Equipment, in place. If the Equipment is altered or removed before EGC has made such inspection or waived its right to do so, the obligations of EGC under this Limited Warranty will be deemed to have been satisfied.

## **8. Proof of Purchase**

Notwithstanding anything to the contrary in this Limited Warranty, Purchaser must, upon The EGC's request, submit proof of original purchase (satisfactory to EGC) of the Equipment. The Limited Warranty set out above shall not apply to, nor cover, any Equipment for which Purchaser is unable, upon the EGC's request, to supply such proof of purchase.

## **9. Limitation of Actions**

Any legal action against the EGC for a default of its obligations under this Limited Warranty must be commenced within two (2) years from the date the Equipment was sold by an authorized dealer of the Equipment.

## 10. How to Obtain Service

If a problem with this Equipment develops during or after the warranty period, proceed as follows:

- A. Refer to your Operator's Manual and follow the Troubleshooting Table within the 'Service Section'.
- B. Contact the authorized Equipment Distributor from whom you purchased the Equipment.
- C. Contact the EGC Service Manager at the most convenient phone number listed below:

1 (800) 321-0757 outside Ohio, but within the U.S.A.

1 (800) 537-3479 within the State of Ohio

1 (216) 961-3500 within the 216 area code or outside the continental U.S.A.

1 (216) 961-3641 fax number in Cleveland, Ohio

1 (800) 387-7621 within Ontario

1 (519) 770-4621 outside Ontario, but within Canada

1 (905) 670-0324 fax number in Canada

SERVICE CALLS WHICH DO NOT INVOLVE DEFECTIVE MATERIALS OR WORKMANSHIP AS DETERMINED BY EGC IN ITS SOLE DISCRETION ARE NOT COVERED. COSTS OF SUCH SERVICE CALLS ARE THE RESPONSIBILITY OF THE PURCHASER.

EGC wants you to remain a satisfied customer. If a problem occurs that cannot be resolved to your satisfaction, please contact us immediately, Phone one of the numbers listed above or write to:

E-max Gaming Corporation  
C/o National Service Manager  
9900 Clinton Road  
Cleveland, Ohio 44144

Please be sure to include the name, model number, serial number, date of original purchase, and the distributor from whom you purchased the Equipment, as well as any actions taken to correct the problem.

# Console Diagrams

## Appendix

# A

In this section there are diagrams for:

- ❖ Computer System Connectors
- ❖ AC Power Connections
- ❖ Data Router Field Connector Pin Definitions

### INTERNAL CONSOLE WIRING SIDE

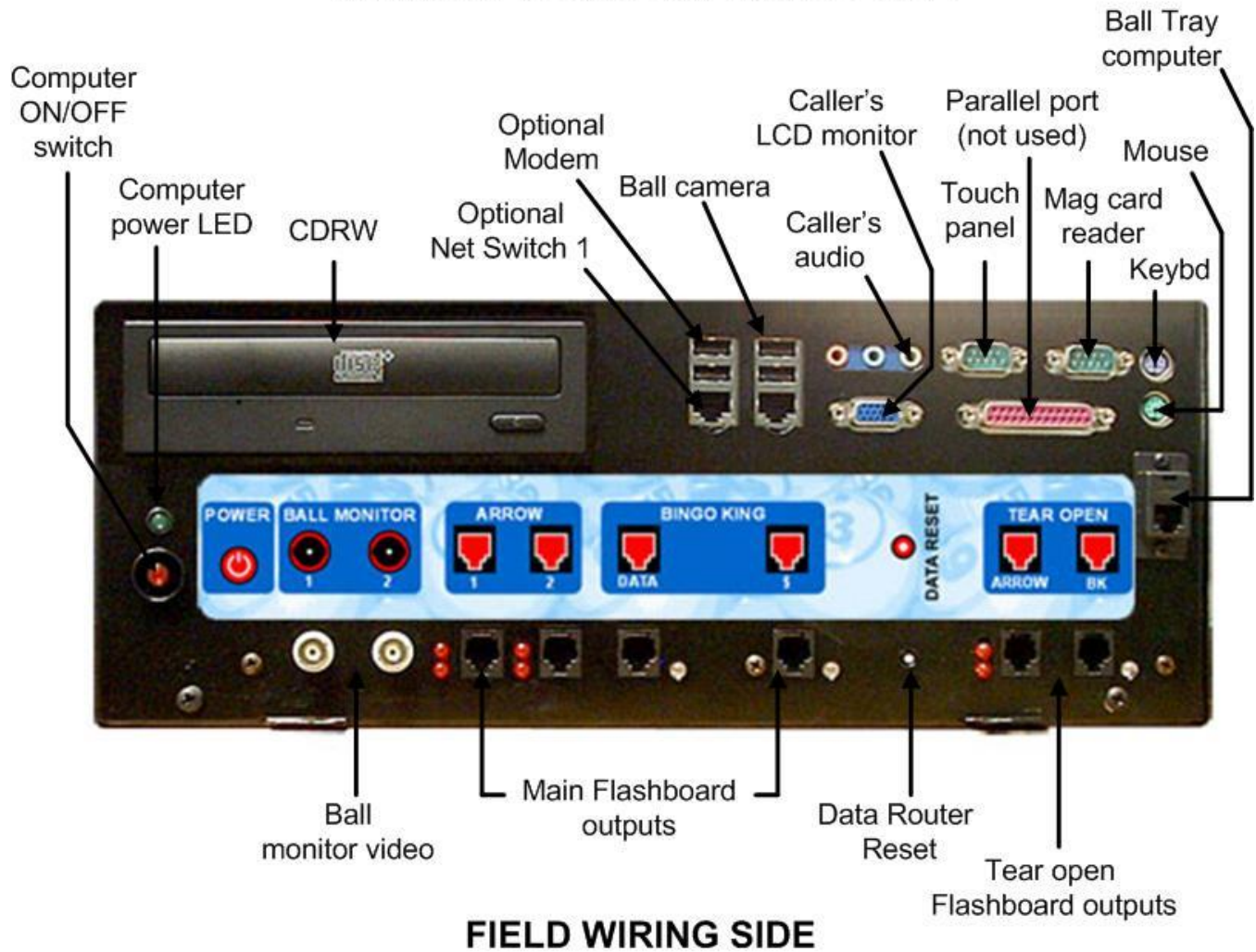

# EXPRESS CONSOLE AC POWER CONNECTIONS

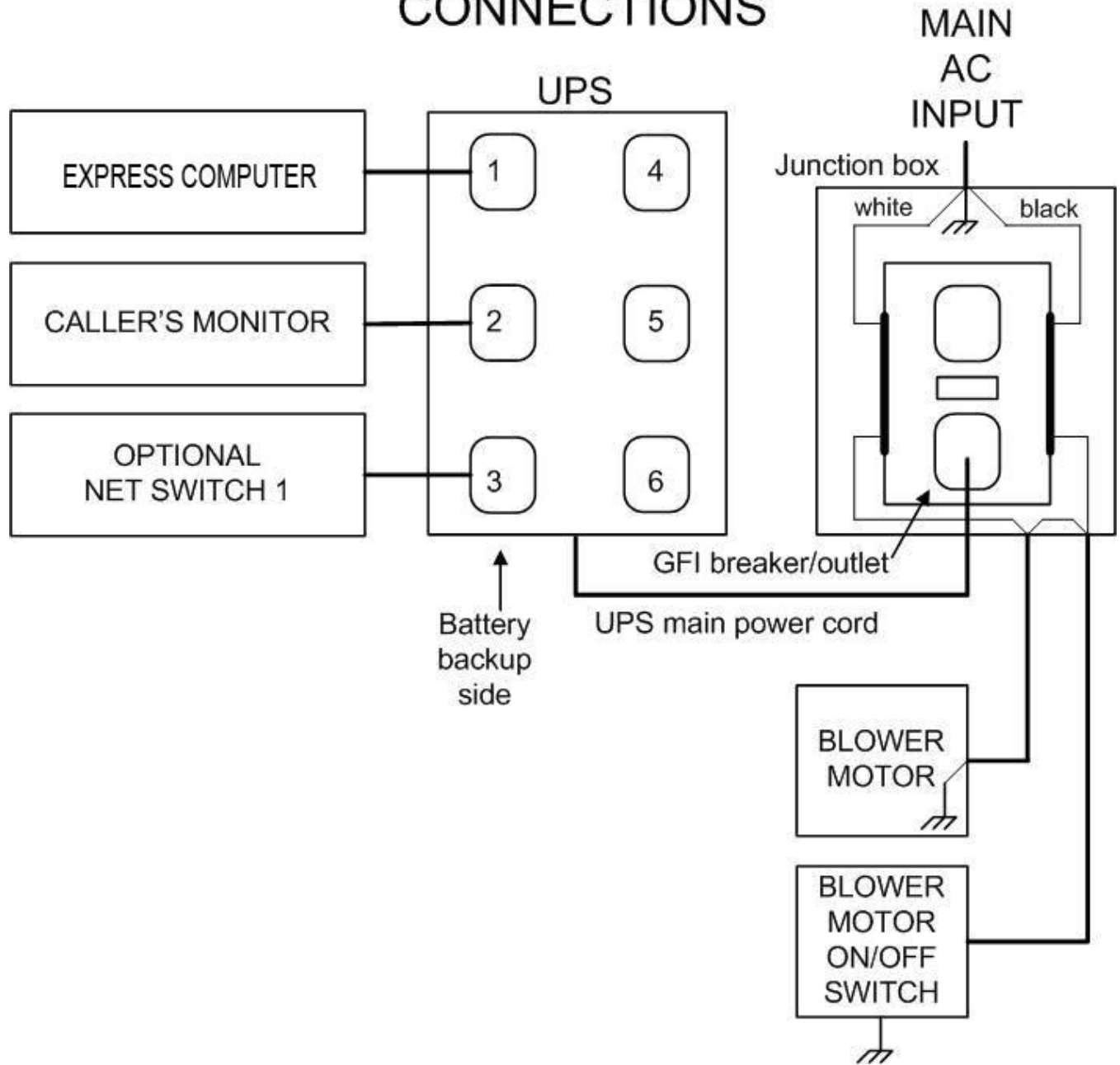





## EXPRESS COMPUTER/DATA ROUTER CONNECTOR PIN OUTS

### ARROW MAIN FLASHBOARD OUTPUTS

- 1.
2. GND
3. \$VALUE SIGNAL, 0-5V, 150ma
4. GND
5. GAME INDICATOR SIGNAL, 0-5V, 150ma
- 6.

### BK DATA FLASHBOARD OUTPUT

- 1.
- 2.
3. BK B DATA SIGNAL, 0-5V, 150ma
4. GND
- 5.
- 6.

### BK \$VALUE FLASHBOARD OUTPUT

- 1.
- 2.
3. BK \$VALUE SIGNAL, 0-5V, 150ma
4. GND
- 5.
- 6.

### ARROW TEAR OPEN FLASHBOARD OUTPUT

- 1.
2. GND
3. \$VALUE SIGNAL, 0-5V, 150ma
4. GND
5. GAME INDICATOR SIGNAL, 0-5V, 150ma
- 6.

### BK TEAR OPEN FLASHBOARD OUTPUT

- 1.
- 2.
3. BK B DATA SIGNAL, 0-5V, 150ma
4. GND
- 5.
- 6.

**BOTH VIDEO CONNECTORS ARE 75 OHM BNC COMPOSITE VIDEO LINE DRIVER**

# Specifications

---

## Appendix

# B

### Disclaimer:

Not all consoles are shipped with identical specifications and equipment and the following specifications are intended as a base line reference for the performance of the E-max product line. Specifications are subject to change without notice because of the dynamic aspect of the computer hardware and software marketplace.

### General Features of Electronics Console:

Slate gray wood cabinet with black trim, modular design

Heavy duty casters, rear locking front non-locking

One key lock, two keys

UPS, Internal, 10 minute backup

Computer:

Intel CPU Pentium M

512 MB RAM, 40 GB hard drive, CDRW drive,

Sound, 1 VGA video port, 4 USB ports,

1 parallel port, 2 serial ports, 2 Ethernet ports,

Reduced size keyboard, mouse

Operator display:

15" color LCD flat display:

Touch panel, speakers, magnetic card reader

Internal Data Router to computer housing:

1 Ball tray computer serial port

2 Arrow main flashboard outputs, each with both G.I., \$value and status LEDs

1 BK B Data main flashboard output with status LEDs

1 BK \$value flashboard output with status LEDs

1 Arrow & 1 BK Tear Open flashboard output with status LEDs

2 BNC connectors with same composite video output

Software switched external video

Manual back up mode when computer fails

CDs- restore application, database, and blank backup

Magnetic card reader for security access

1 year warranty

## General Features of Ball Console

- 75 ball console
- Slate gray cabinet with black trim, modular design
- Red / Green / Silver ball chamber
- Arm rest
- Heavy duty casters, rear locking, front non-locking
- Sealed Ball bearing blower motor with power on/off switch
- Hepa air filter (HH246 Filter Replacement)
- Anti-static control and metal ball tube
- Dual ball chambers for reduced noise
- Integrated digital camera
- LED ball illumination
- Spill resistant rubber ball switches
- Raised ball for easy removal from ball tray
- Integrated ball tray computer
- Cup holder
- 1 set of double numbered bingo balls

## Detailed System Specifications

### Size:

52" wide x 32" deep x 30" high, + 15" high for the monitor  
240 lbs

### Environment:

Indoor use only, no condensation  
Recommended Operating Temperature: 15C to 35C (59F to 95F)  
Storage temperature: -5C to 45C (23F to 113F)

### Regulatory:

Components are designed to meet or are UL and CSA approved

### Electrical:

Flashboard outputs:

0 to 5V output, up to 150ma sink or source, short circuit and ESD protected  
Fused for severe damage

Video outputs:

Composite video – 0 to 5V max, 75 ohm output, RCA jack

Audio outputs:

0 to 5V max, signal levels and output impedance not intended to directly drive speakers, stereo 3.5 mm receptacle

Audio input:

Signal levels compatible with standard PC sound card, MIC IN circuitry.

Power Input:

60 Hz, 115 VAC nominal, 103 VAC min, 126 VAC max  
Service feed wire must be 14 AWG or better and must be able to support 15 A.  
Power should be reasonably free of noise and large surges.  
Console will operate from the UPS for up to 10 minutes in the event of a power failure

## Gaming Related Specifications:

### Software Architecture:

MSWindows XP Pro operating system with custom Arrow gaming application shell.  
Gaming operator never has access to the Windows operating system

### Perms:

Verifies all Arrow paper perms – other perms available on special request

Tracks paper serial numbers

**Security:**

Three levels of system security for personnel access to equipment and gaming operations

User can change password

Encrypted hard drive for maximum gaming security

Loads only Arrow generated gaming CDs

**Operations:**

Supports multiple organizations and multiple sessions on one console with security access

Operator can interchangeably use touch panel, keyboard, or mouse for input

Balls wrongly inserted in the ball tray can be easily reset on the operator screen

Live, digital ball camera image (picture-in-picture) on operator screen

Supports multilevel payouts and generates payout report

Hundreds of factory pre-loaded game patterns

Powerful, yet easy to use new pattern generator

Logs all gaming activity to a file which can be printed or recorded on a CD

Back up CDs can be generated to protect gaming setups and database

Console Operator Manual stored on the hard drive

**Networking:**

Two Ethernet ports for maximum flexibility. (Customer specific applications)

Optional external modem for remote dial out and remote reports

**BINGO CONSOLE SECURITY TABLE:**

Main Menu Function	Operator (Operator +)	Manager	Technician (4)	Sys Admin	Regulatory (4)	E-max Support
Multiple Organizations	NO	YES (1)	YES	YES	NO	NO
Activate	NO OP+, YES	YES	YES	YES	NO	NO
Play Bingo	YES	YES	YES	YES	NO	NO
Setup	NO	YES	YES	YES	NO	NO
Utilities	YES (5)	YES (5)	YES (3)(5)	YES	YES (5)	NO
Deactivate	NO OP+, YES	YES	YES	YES	NO	NO
Log out	NO	YES	YES	YES	YES	NO
Restart	YES	YES	YES	YES	YES	NO
Shutdown	YES	YES	YES	YES	YES	NO

Utilities Function	Operator (Operator +)	Manager	Technician	Sys Admin	Regulatory	E-max Support
User Security	NO	YES(2)	NO	YES	NO	NO
E-max MDL	NO	YES	YES	YES	NO	NO
Hardware set	NO	NO	YES	YES	YES	NO
Maintenance	NO	NO	NO	YES	NO	NO
Backup	NO	NO	NO	YES	NO	NO
Restore	NO	NO	NO	YES	NO	NO
Upgrades	NO	NO	YES	YES	NO	NO
Lamp test	YES	YES	YES	YES	NO	NO
Device test	YES	YES	YES	YES	YES	NO
Calibration	YES	YES	YES	YES	NO	NO
Renew license	NO	NO	NO	YES	NO	NO
Set clock	NO	NO	NO	YES	NO	NO
<b>Reports:</b>						
Utilization	NO	YES	YES	YES	YES	NO
Revenue share	NO	YES	YES	YES	YES	NO
Device	NO	YES	YES	YES	NO	NO
Device load	NO	NO	YES	YES	YES	NO
Gaming	NO	YES	YES	YES	YES	NO
Payout	NO	YES	YES	YES	YES	NO
Frequency	NO	YES	YES	YES	YES	NO
<b>Logs:</b>						
Download	NO	NO	YES	YES	NO	NO
Package builder	NO	NO	YES	YES	NO	NO
Error	NO	NO	YES	YES	NO	NO

Phone reports	Operator	Manager	Technician	Sys Admin	Regulatory	E-max Support
Regulatory	NO	NO	NO	NO	YES	NO
Distributor	NO	NO	YES	YES	NO	NO
EGC	NO	NO	NO	YES	NO	NO